

# Make a Paper Leon Cathedral





## Leon Cathedral

It is a Gothic Cathedral that began building around the year 1205. It faced many problems and set backs but the fundamental structure of it was completed in 1302 when it was opened to the faithful. Work continued on it into the mid 15th century when it was virtually finished. Although more work, construction, and repairs have been done to it right into the 19th century.

Another famous aspect of the cathedral, other than its gothic architecture is its collection of medieval stained glass which is one of the largest collections in the world.

I visited the city of Leon and this Cathedral. You can read more, learn more and view pictures on my website here: [Will visits Leon](#)

### Tips for making this paper cathedral project

**To save printer paper and ink you don't have to print up this whole document. You just have to print out, onto card stock, the pages of parts.**

**Two versions:**

**In this document there is a complete version of the cathedral with all blank white parts. This is so you can put it together and decorate/paint/color it any way you like. Those are pages 24 thru 33.**

**There is also a colored version of the cathedral that you can print up on card stock and put together with no need for coloring. Those are pages: 34 thru 43.**

I recommend you build this paper project using card stock. It is thicker than normal printer paper and much easier to use. It is more durable and will make a stronger cathedral. I use 90 pound card stock which is available online and readily available at Walmart right alongside regular printer paper.

If you need to order cardstock this is the exact product I purchased on Amazon and use for this project: [Neenah 90 pound cardstock](#)

This card stock is suitable for virtually every desktop printer. And there is quite a variety of it including 110 pound card stock which is thicker and still very suitable for this project.

### **Glue and adhesives -**

You can use any kind of paper glue for this project which includes elmers glue or any white glue.

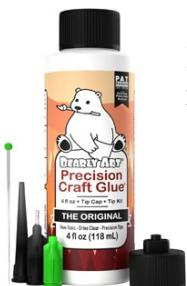

I use Bearly Art Glue. It works very well for me and it comes with precision tips that make application very easy and precise. [Bearly Art Glue on Amazon](#)

Other suggested Tools:

- A metal ruler for measuring, cutting and folding
- Scissors
- A craft knife or x-acto knife
- A bone folder for folding and creasing

### Tips for construction

Dashed lines are fold lines; and dotted lines show where another part will be glued.

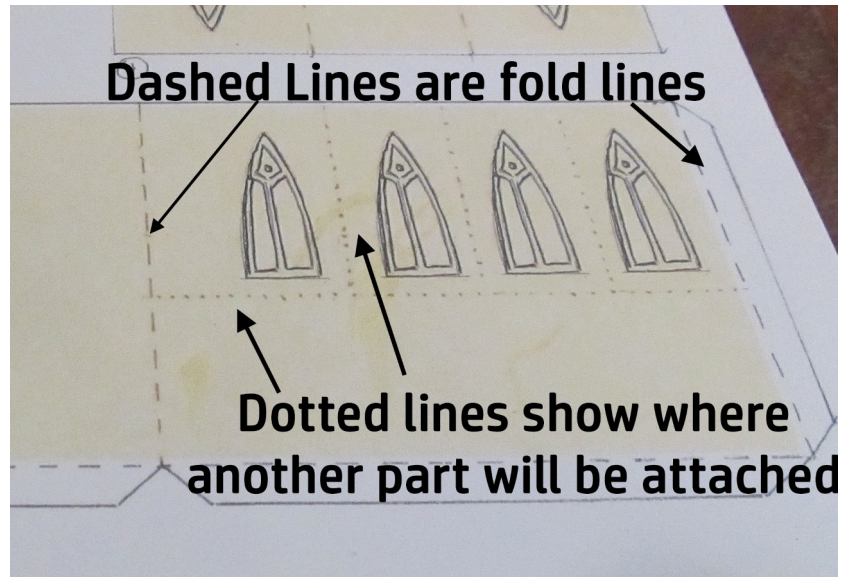

A great way to fold clear and crisp straight lines is to use a metal ruler.



And when cutting out small areas an xacto knife really works well; particular on the flying buttresses.

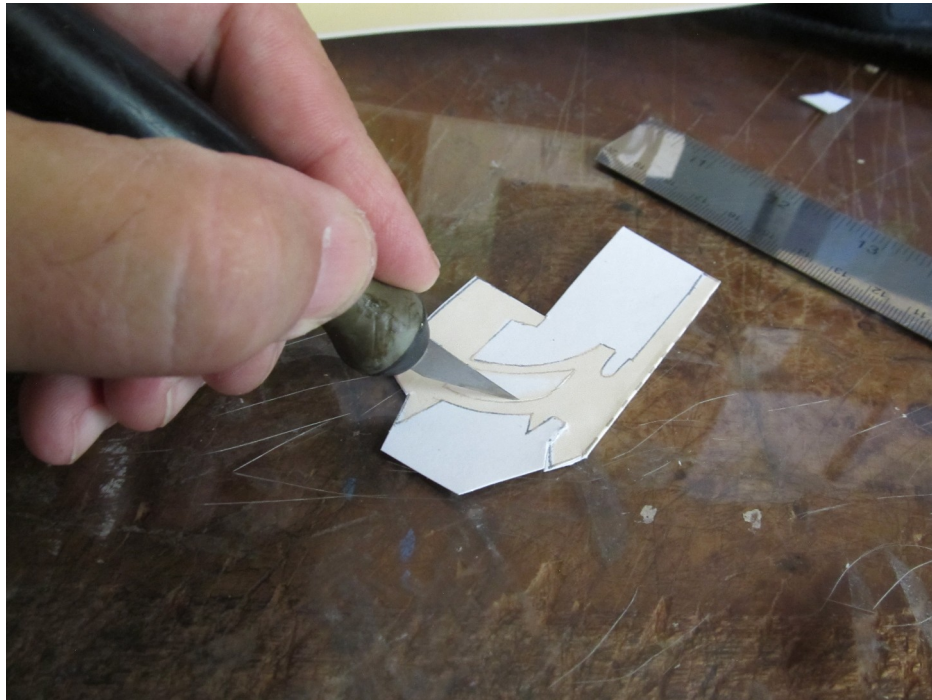

I made this assembly procedure easy for you to follow. Each part is numbered as you assemble the cathedral. You start with part 1 then you add part 2, then add part 3 etc. All the way through part 59.

I recommend you don't cut the parts out ahead of time. Cut out each part as it is needed for the assembly. This will avoid any confusion, particularly with the flying buttresses. There are several different types of buttresses. They look similar but are different in size and where they go on the cathedral.

## ASSEMBLY PROCEDURE STARTS HERE

Start with part 1 of the pieces. Part 1 is the whole page, no cutting necessary. It is the base of the whole model. Apply glue to the page as shown by the blue lines.

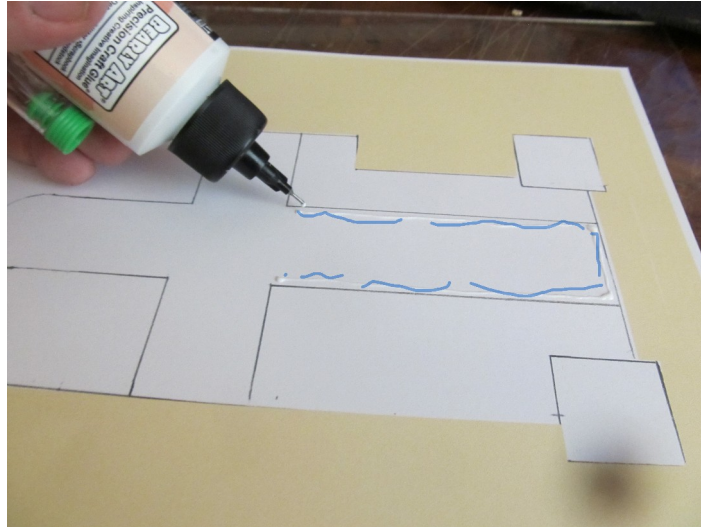

Cut out part 2, crease and fold it and then apply it to part 1 as you see here. Notice how the two flaps are folded outwards as shown by the blue arrows.

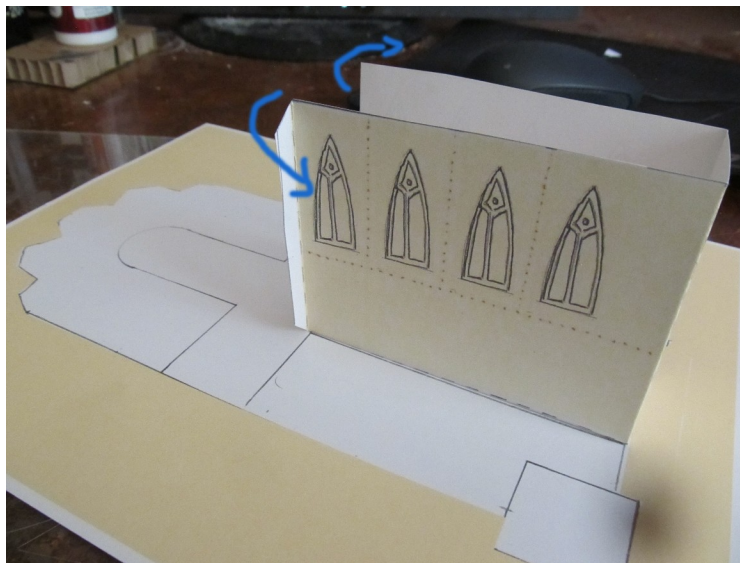

Cut out parts 3 and 4, fold and crease them and glue them both to the base sheet and to part 2 as shown here.

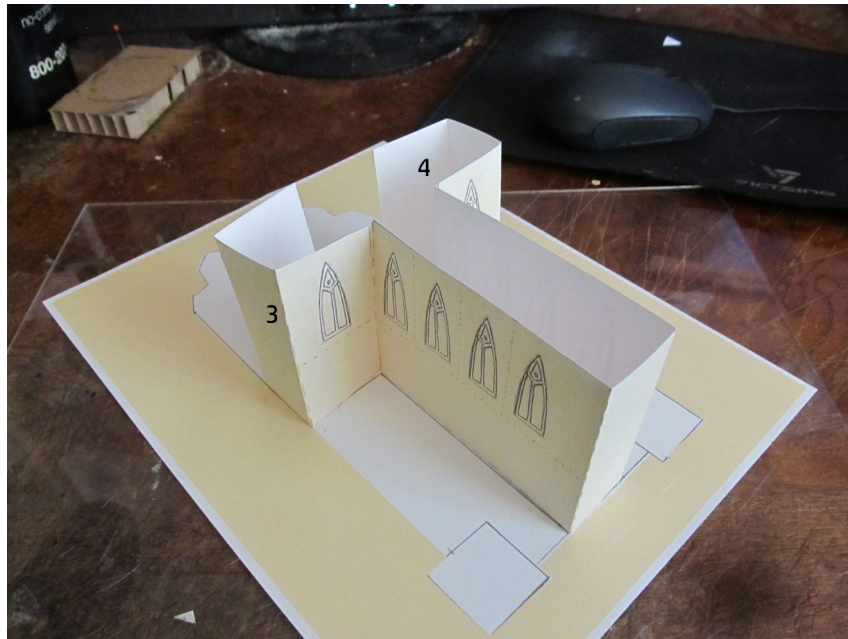

Repeat this process with part 5. This will complete the cruciform walls of the cathedral.

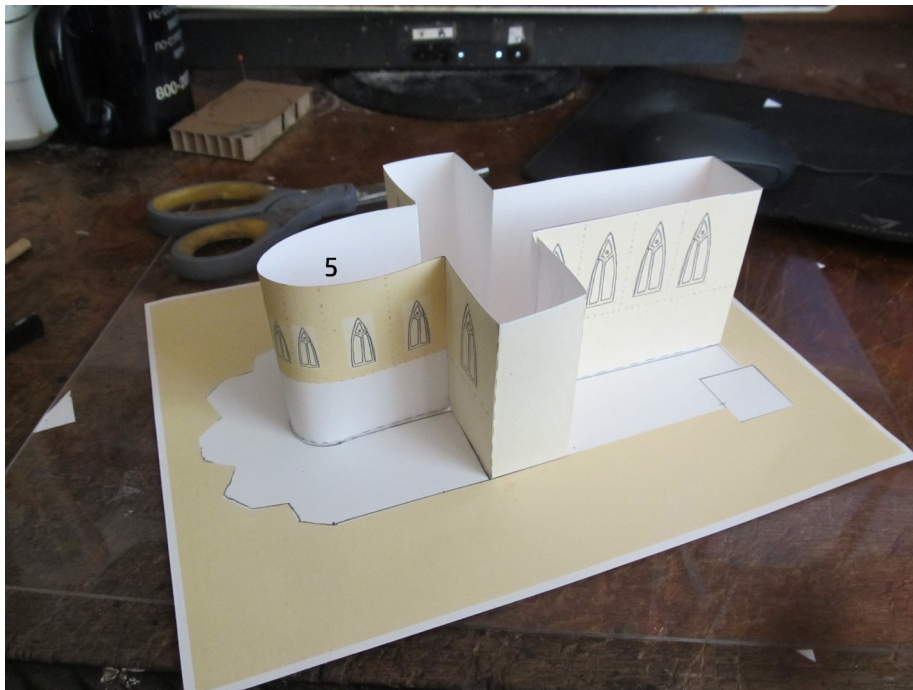

Cut out part 6, crease along the dashed lines and fold up the edges like you see here in the picture. The colored edges are visible and point inward.



And glue it into the top of the cruciform structure. The colored edges of part 6 are flush with the top of the cruciform edges.

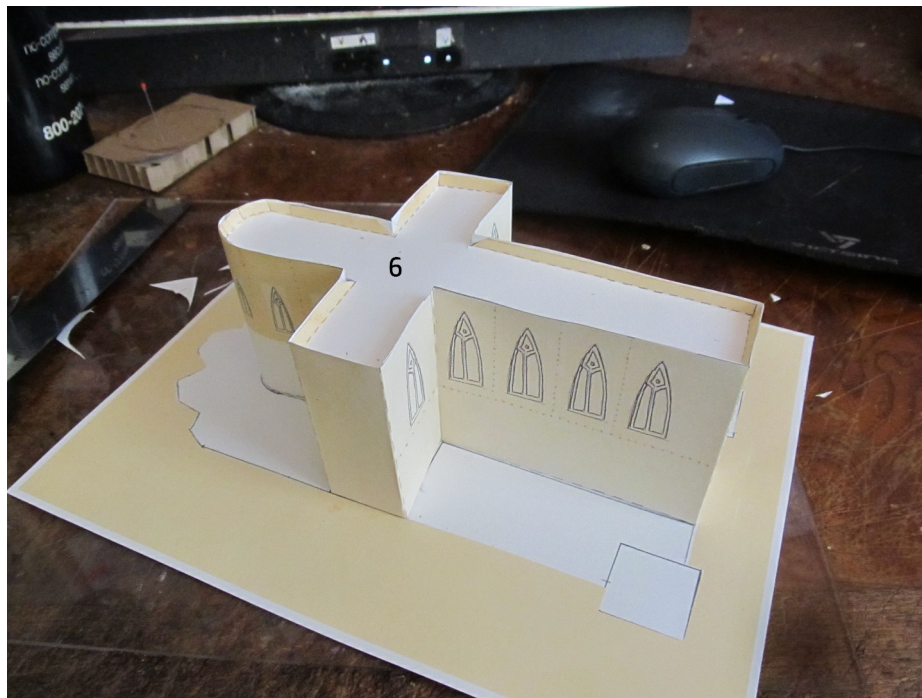

Cut out pieces 7, 8, 9 and 10. Crease them as you see in the picture here. Note that parts 9 and 10 are identical. But Part 8 is a bit larger than them. This makes a difference when you glue them onto the cathedral..

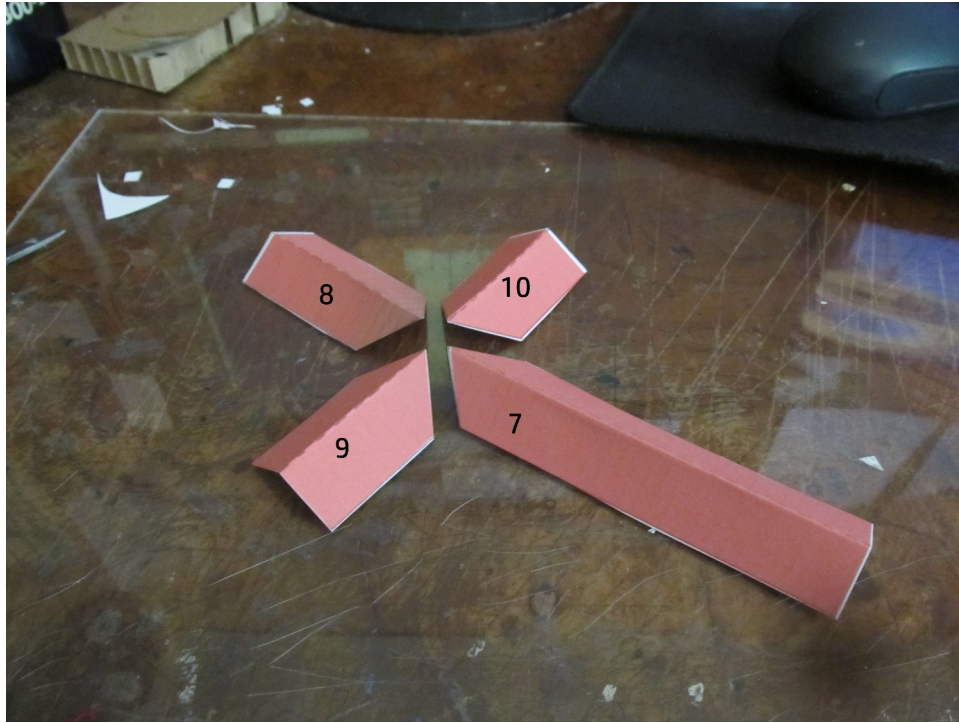

Glue them into place.

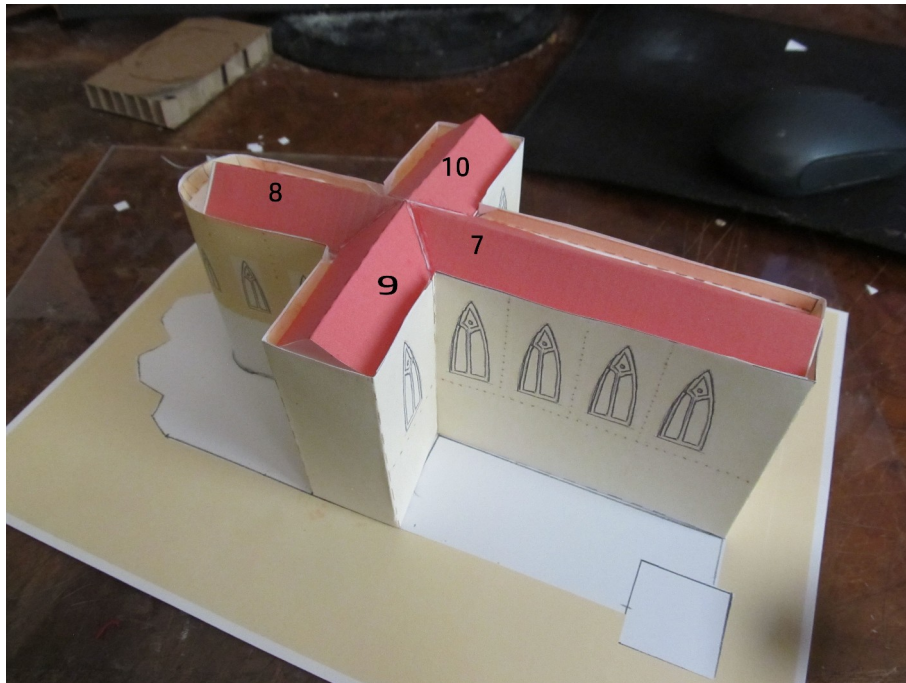



Cut out part 11 and fold all the flaps inward as you see here.

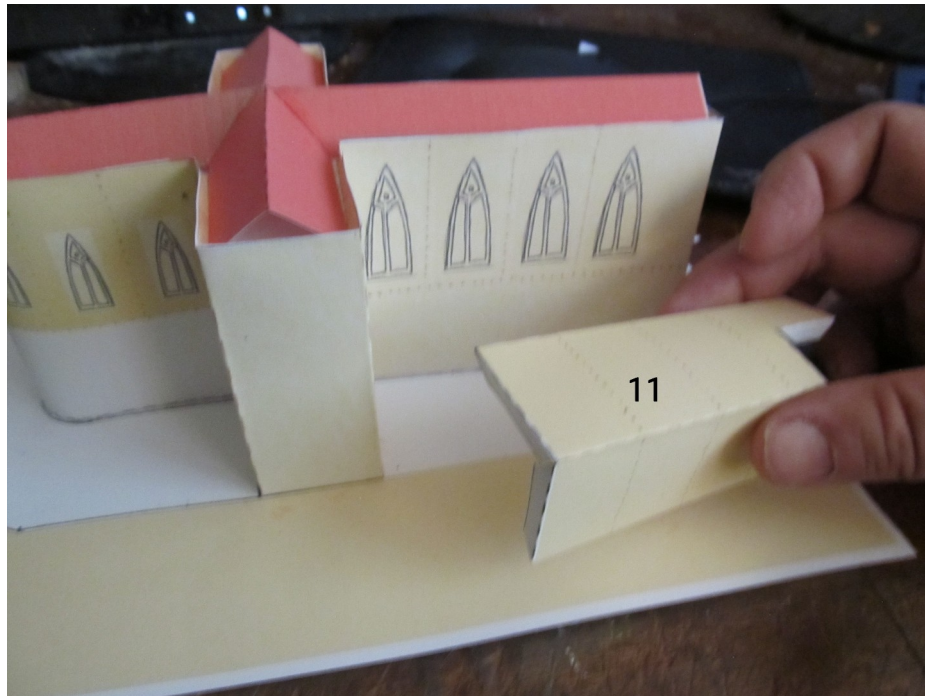

Then glue it to the cathedral as you see here.



Cut out parts 12 and 13, pre-crease them and glue them down to the base sheet as shown here. It is important to pre-crease both these parts along all the dashed lines. It will make it much easier to glue to the base sheet.

**Note** that each of these pieces has a pair of dotted lines! Do not crease on these dotted lines! These lines show you where, in an upcoming step, you will attach the flying buttresses. They are simply guidelines.



Two dotted lines, do not crease

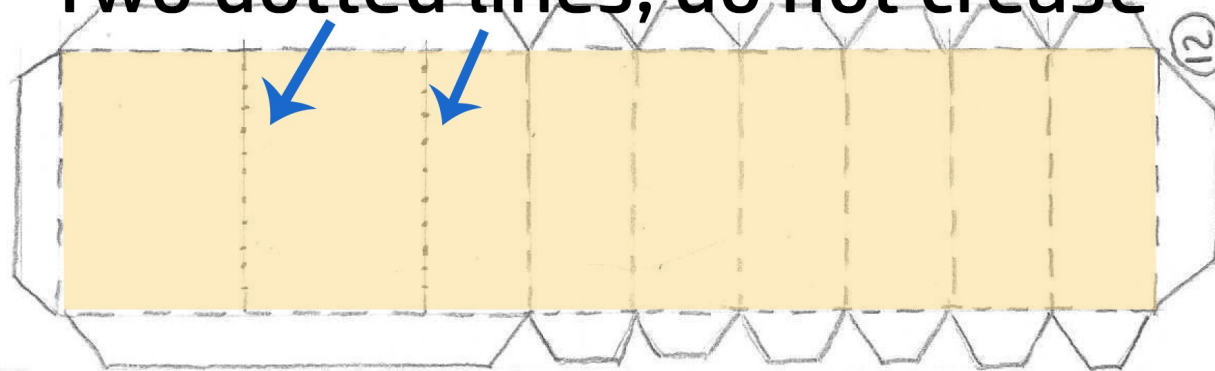

Cut out and prefold part 14. Glue it down to the base as shown. Note that there are three dotted lines on part 14. You don't fold on those lines. They are guidelines showing where buttresses will be glued.

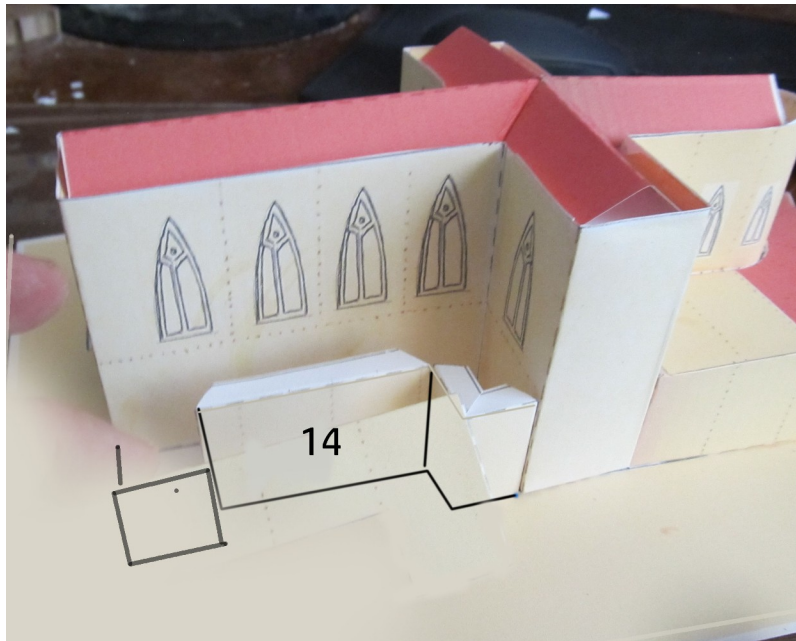

Cut out part 15 and crease it along the dashed lines as shown. Remember, this part has multiple dotted lines. They are not creased.

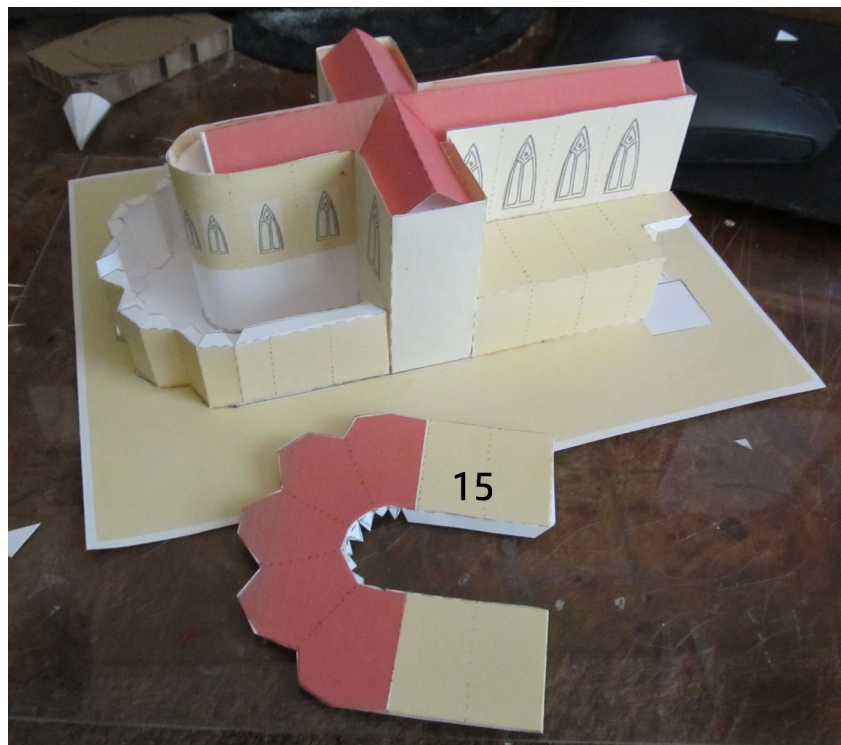

Glue it on to parts 12 and 13 as you see here. Take your time with this. Don't glue it down all at once. Try fitting it into place first and trim it as needed, recrease the folds as needed so it fits comfortably and easily.



Cut out part 16, crease it on the dashed lines and glue it into place on top of part 14.

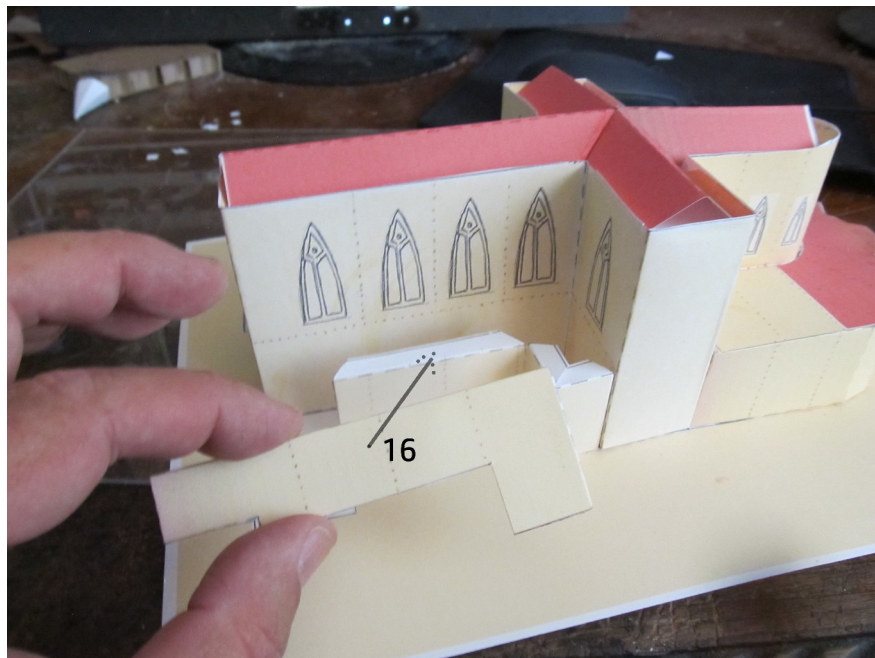

Okay! You are doing great! The major structure of the cathedral has been built. It took two hundred years in real life, but you have made great progress in no time at all!

### Let's get to those flying buttresses!

This paper cathedral has a total of **14 flying buttresses**. And there are **three different types**. We will apply them one at a time all the way around the cathedral. I will take you through the steps but first let me show you how to make the buttresses.

This is how you pre assemble each buttress before gluing it to the cathedral.

Cut the buttress out in a square shape, cutting along the edge of the buttress at edge A and edge B. This is important! You also cut it along the bottom edge as shown by another arrow in the picture below. And.... at the top of the part you cut out a notch as shown by the fourth arrow.

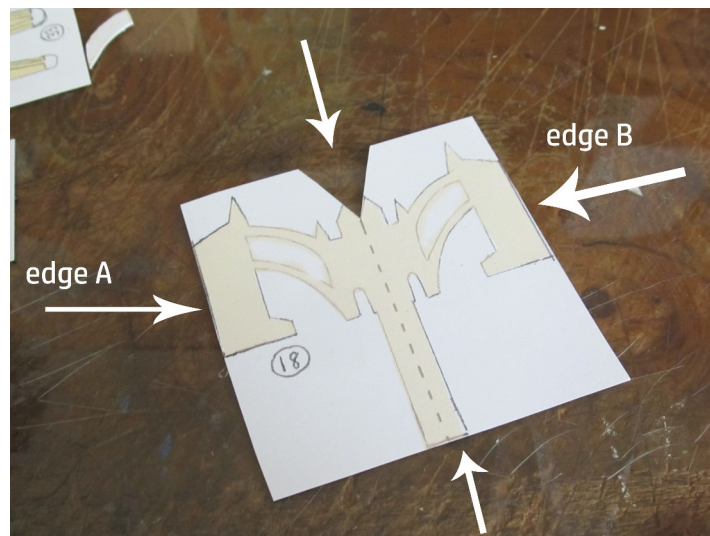

Now use a ruler to fold over the buttress on the dashed line.

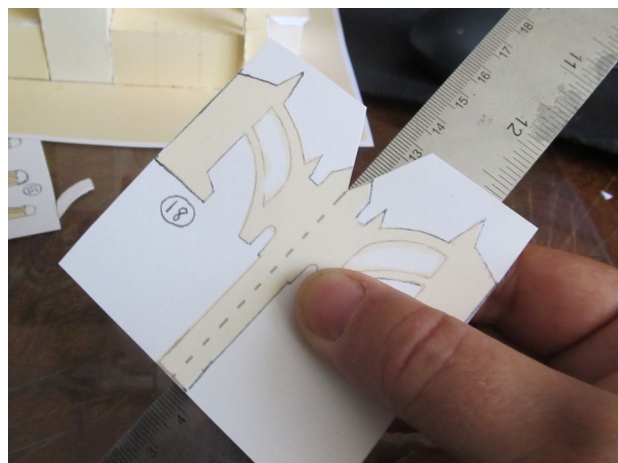

Once you have it folded over nice and cleanly with the edges matching you should glue it, gluing those two halves to each other.

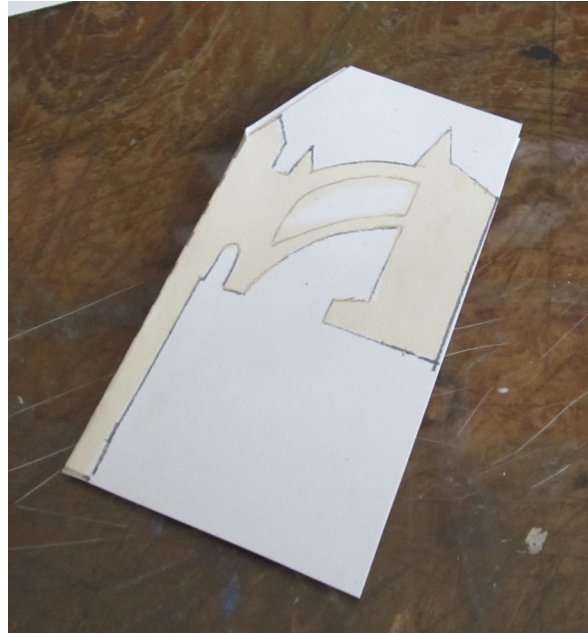

Go ahead and cut out the buttress. Note that some of them have an internal section. Cut this out with an xacto knife if you have one. Otherwise it is a bit tricky to cut out with normal scissors.



The buttress is complete! Looks good.

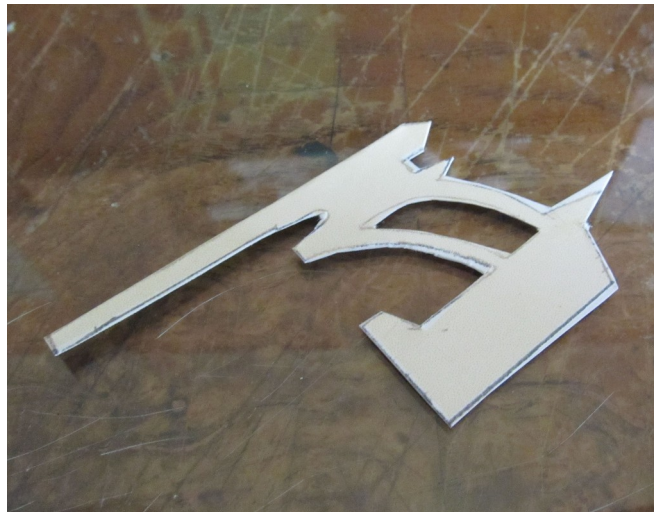

Now that you know how to make the buttresses let's go ahead and place them. There are fourteen in total with three different types.

Note: To avoid confusion you should only cut one out, assemble it, and then glue it to the cathedral. Do this one at a time. If you cut them all out you might get confused as to which one is which.

17, 18, 19, 20, and 21 all go in place like you see here. There are dotted lines on the cathedral showing you where they go.

Before gluing each one in place you should dry fit it. So you can make small trims in it with scissors or xacto knife so it will fit cleanly and neatly. These five are all the same type of buttress.

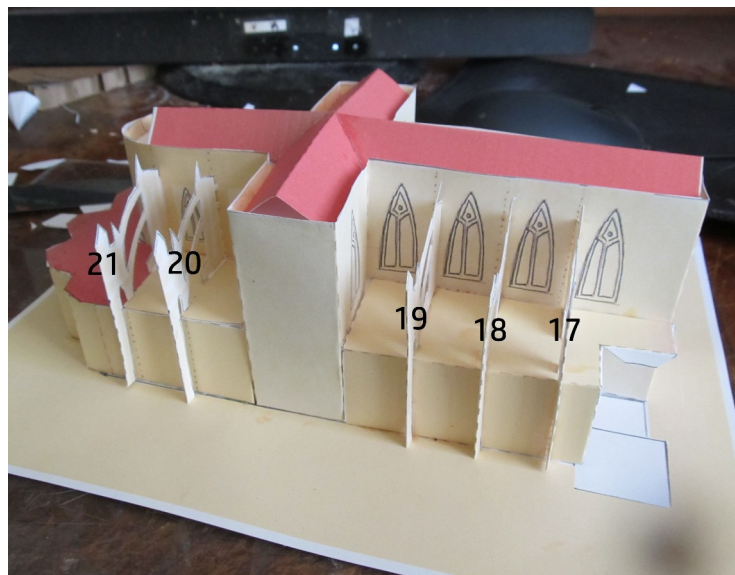

Do the same with 22, 23, 24 and 25. These four are different than the previous five you have done. And these four are all the same.

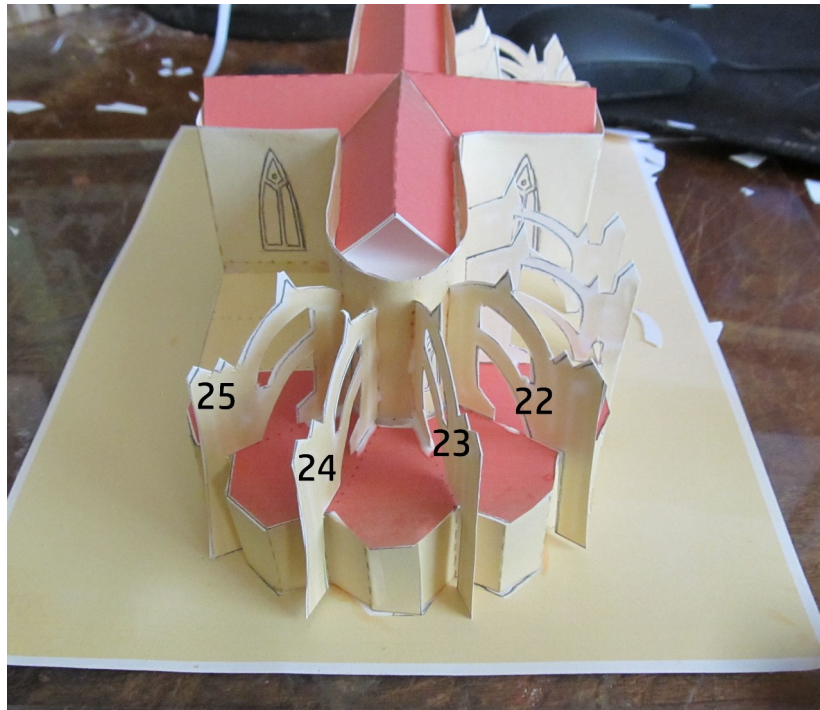

Now finish off the buttresses by installing 26, 27, 28, 29 and 30. This finishes off the buttress work.

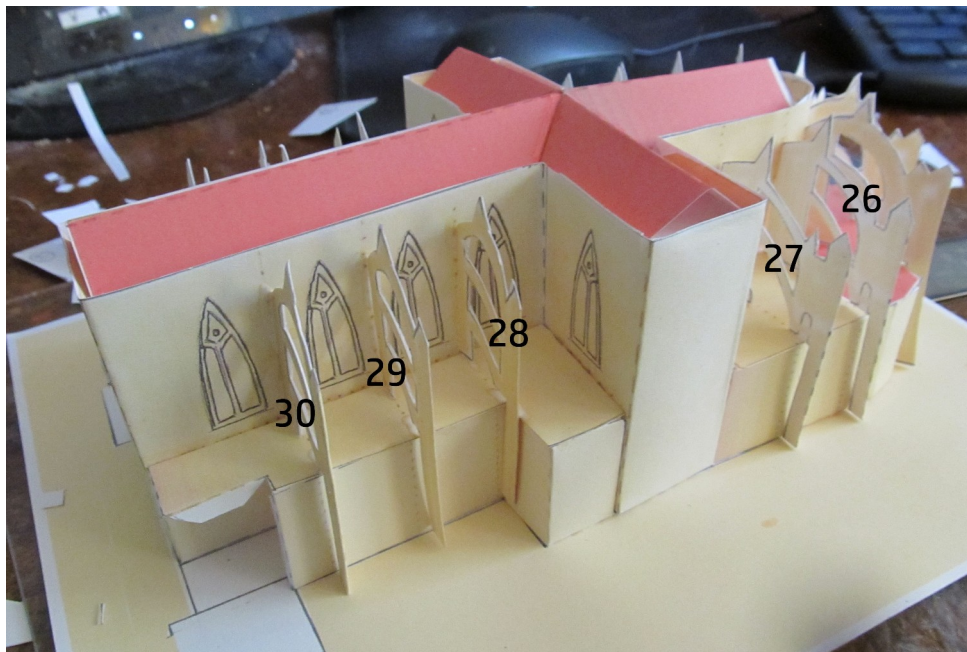



Let's make the two major towers. They are identical. I will walk you through the first one (part 31). You follow the same exact procedure for the second one (part32).

Cut out part 31 like this.

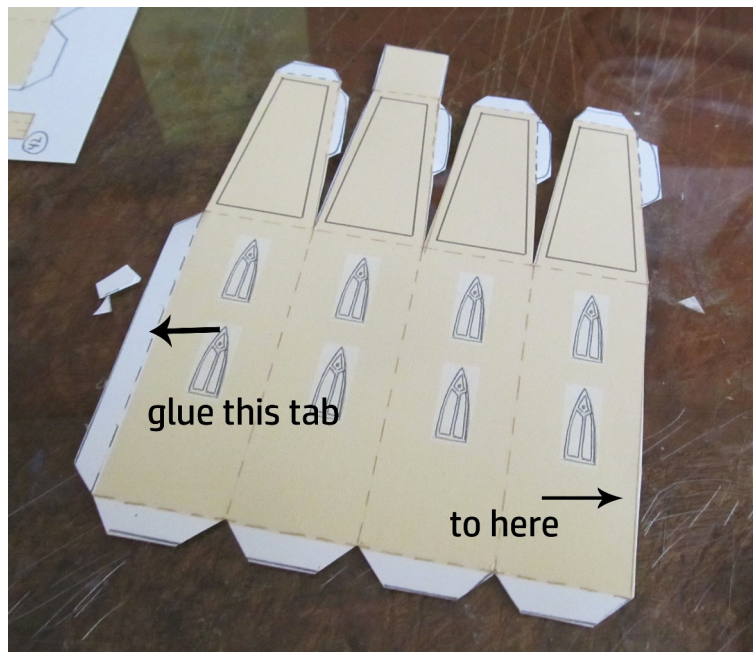

Pre crease all the dashed lines. Then glue it into shape like this. At this stage there is only one glue point. That is along the tab shown by the arrow above.

You end up with this:

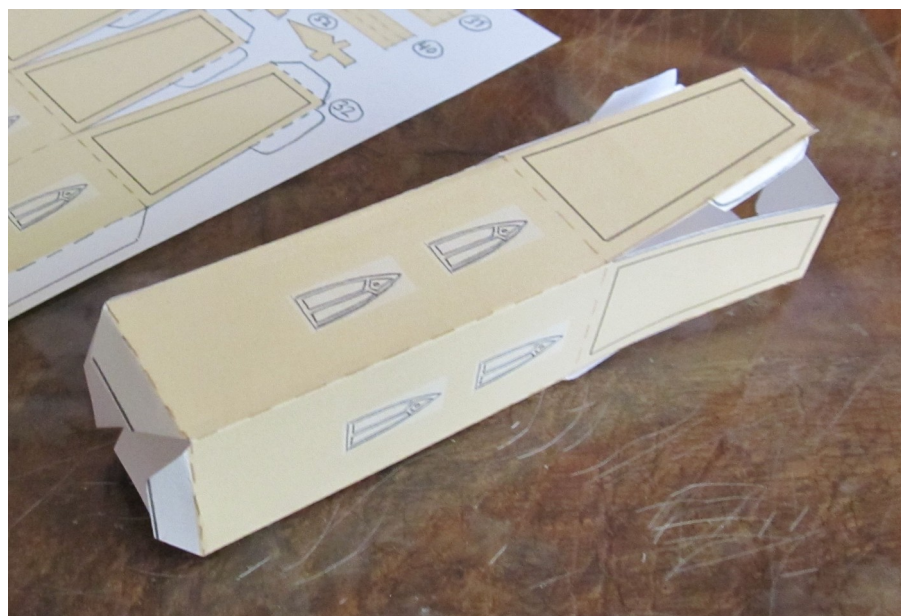

Then glue the top flaps to close up the trapezoidal shape of the tower top section. And there is a flap on the very top. Glue it down.

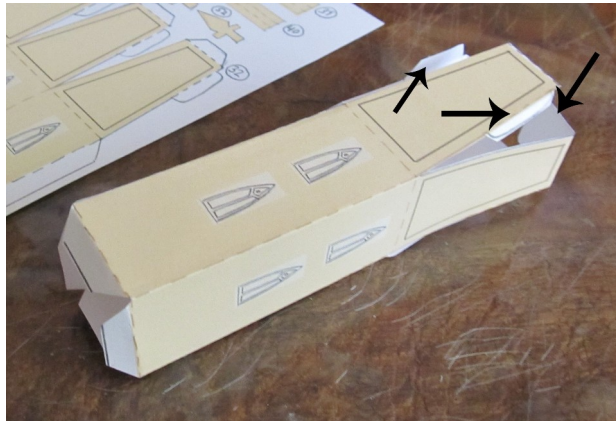

Once 31 and 32 are completed you can glue them into place on the cathedral like this.



Cut out, fold, and install part 33.

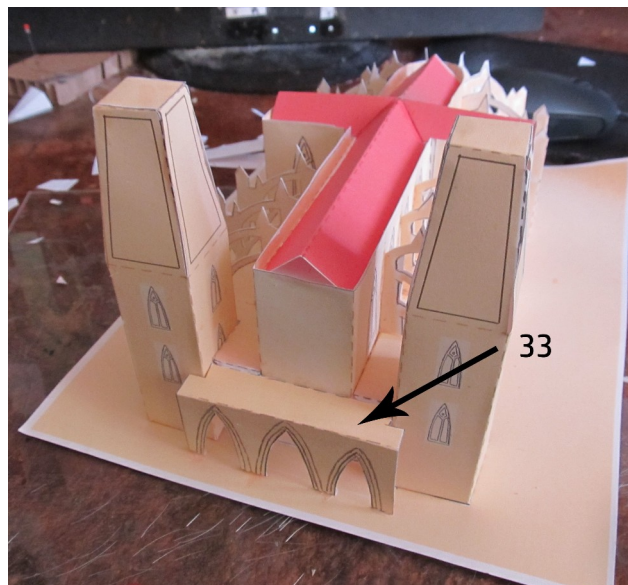

Cut out and install parts 34, 35 and 36.

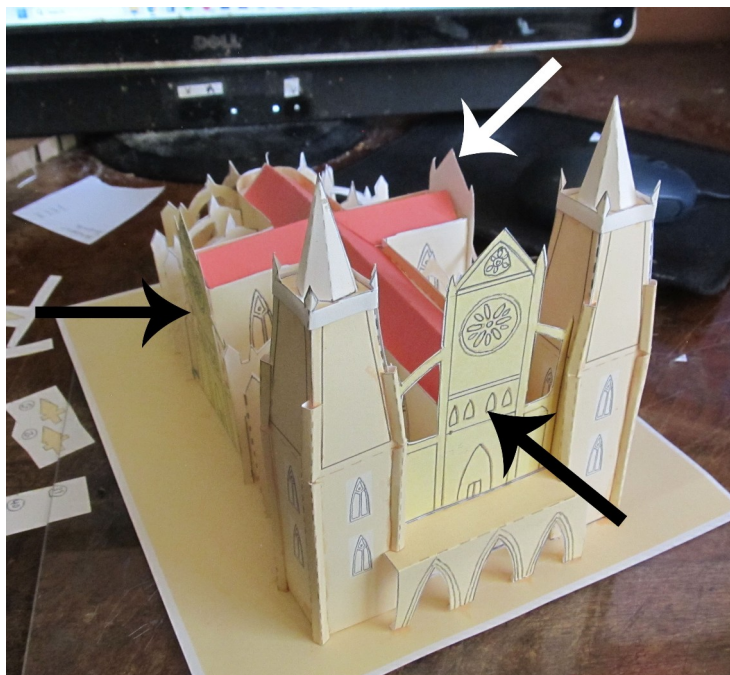

Don't forget to cut out the area under the buttresses.

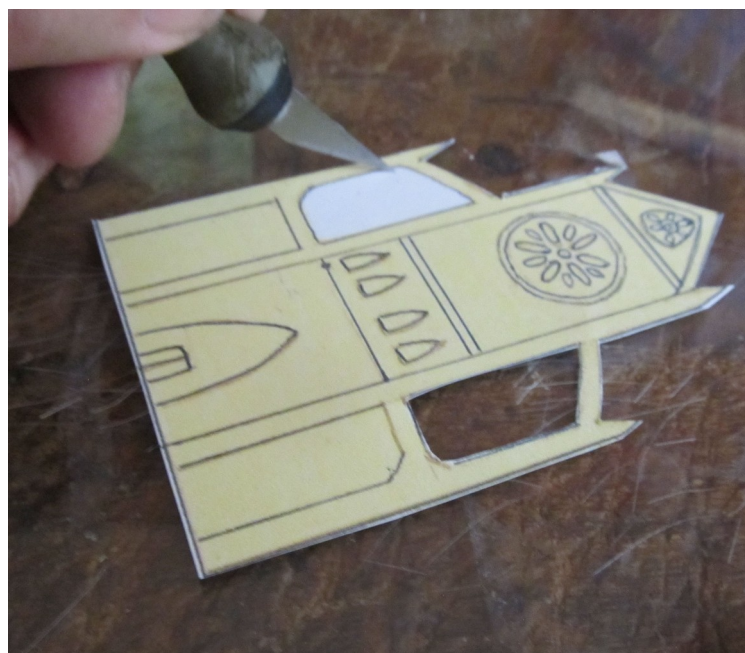

Next we install eight pieces. Four go on each of our large two towers.

These are parts 37 thru 44. There are four long ones and four short ones. This picture shows the four long ones. Fold them all along the dashed lines like you see one of them here. Do the same with the four short ones.

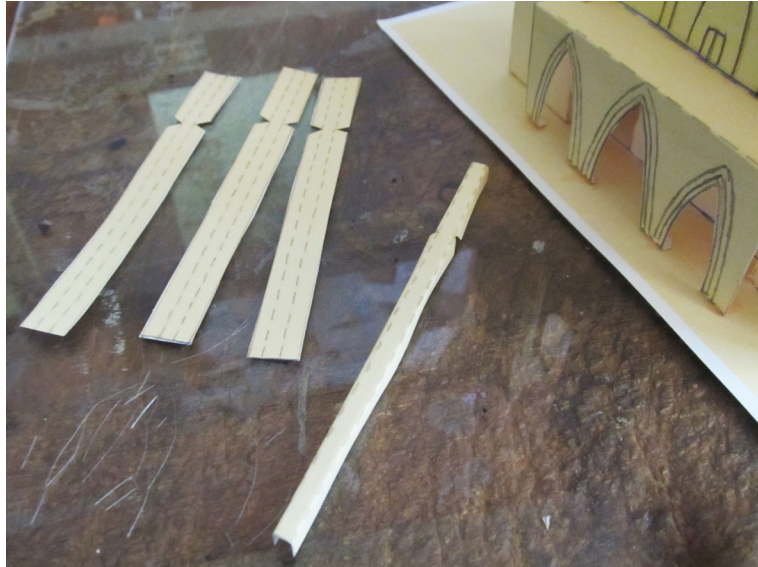

Now attach them all to the two big towers in the front of the cathedral like this. First glue the bottom segment of each piece to a tower and allow the glue to set.

Some of these have been completed. But look at part 37 to see how each piece is glued in two steps. With 37 we have glued the bottom part in place. Once it dries we will then glue that top half in place just like you see with part 41.

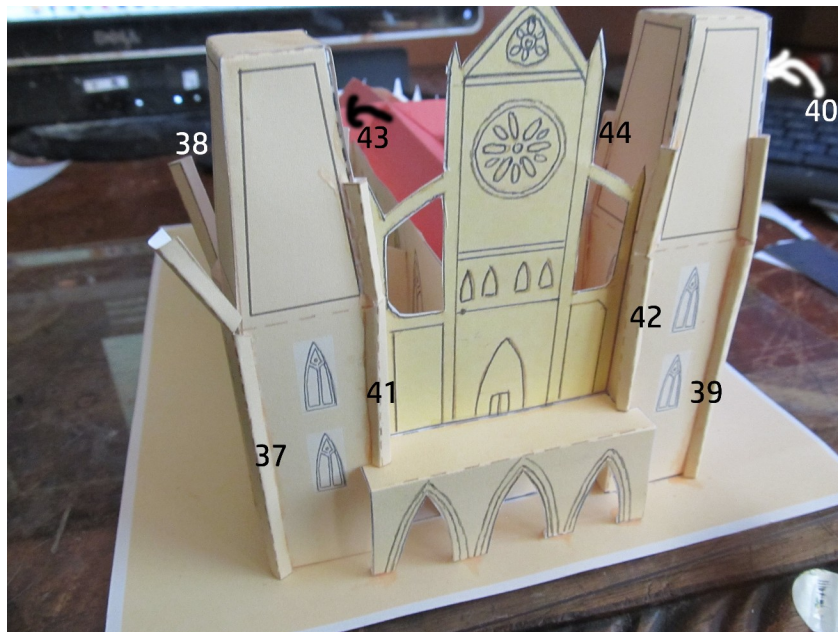

Cut out parts 45 and 46 and glue them around the top of each tower.



Cut out parts 47 and 48. These are the conical tower tops. Fold them along the dashed lines and glue them into their conical shapes. This picture shows one yet to be folded and one that has been folded and glued into shape.

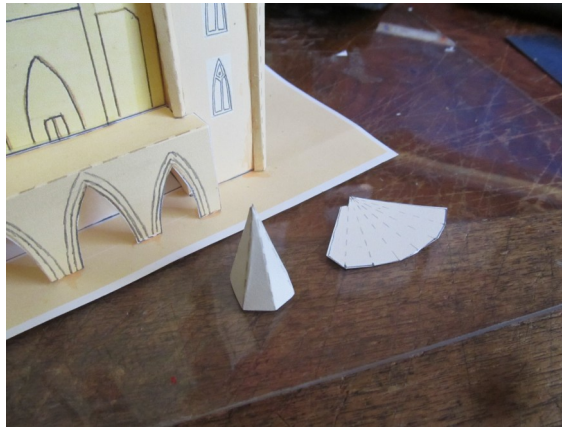

Glue them onto the tops of the towers.



Next we add a small ornamental detail to the tops of each of those eight columns we had glued around the towers. There are eight of them (parts 49 thru 56). This picture shows four of them.

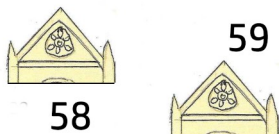
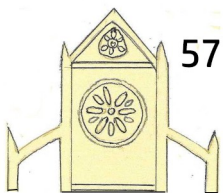
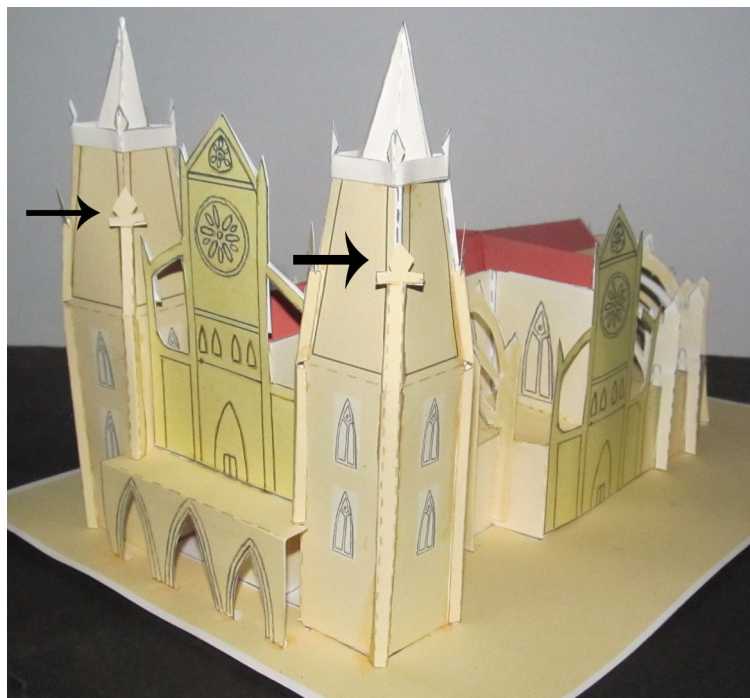
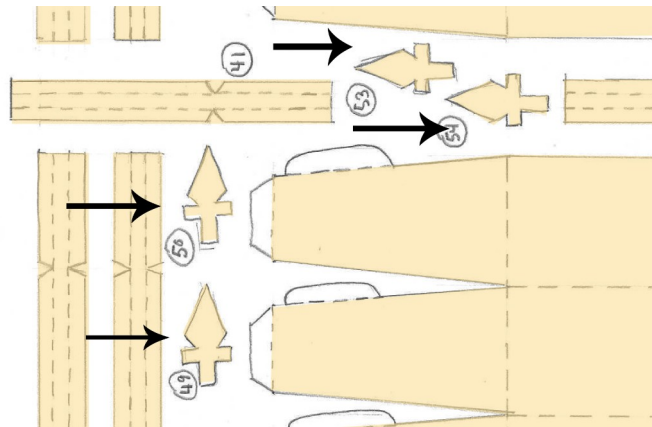

Let's complete this assembly with the final three pieces. (57, 58 and 59)

Cut them out and apply them to the back sides of the three towers.



And with that you can completed your paper Leon Cathedral!

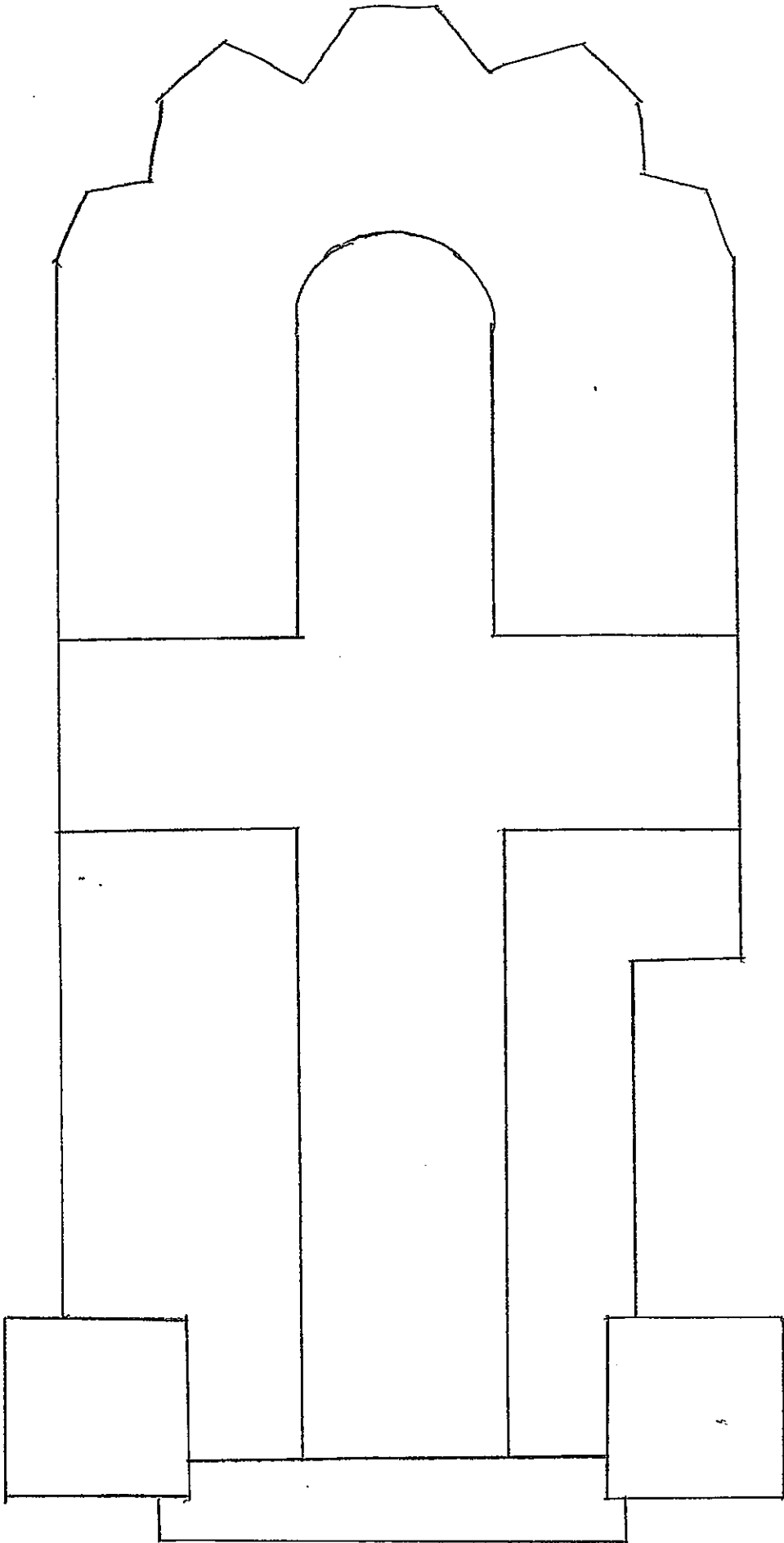



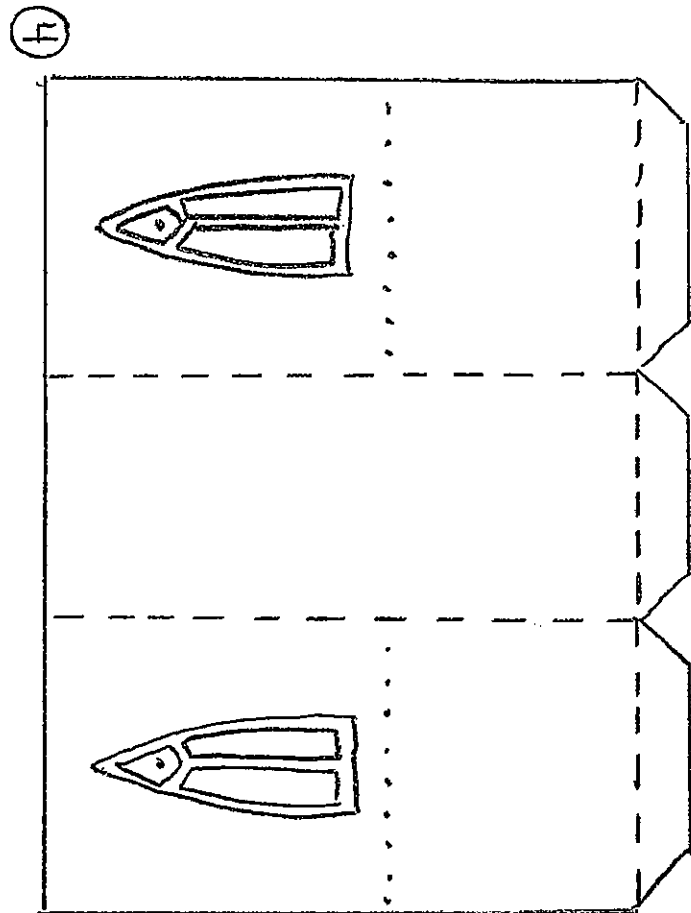
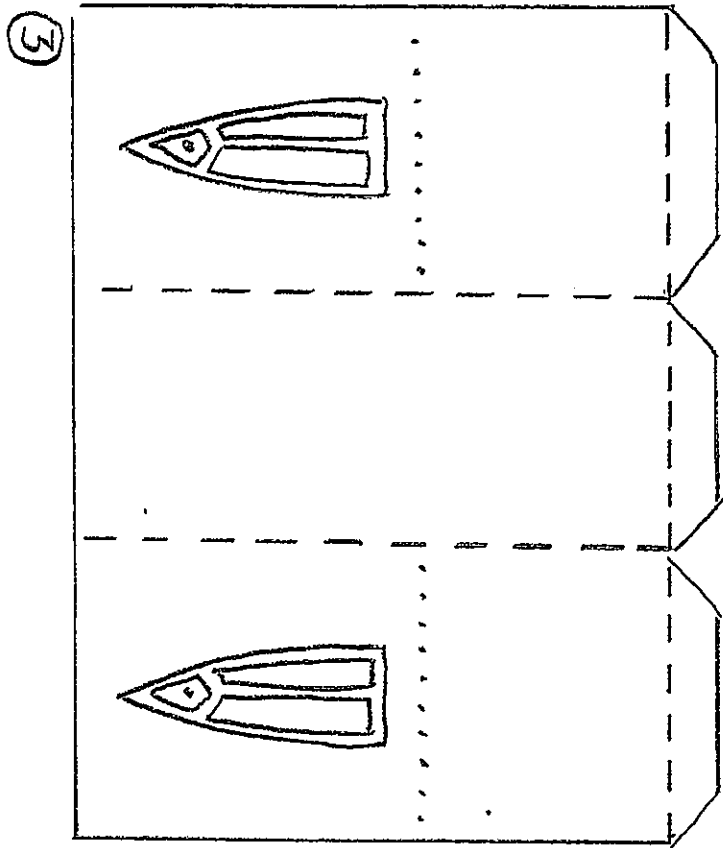
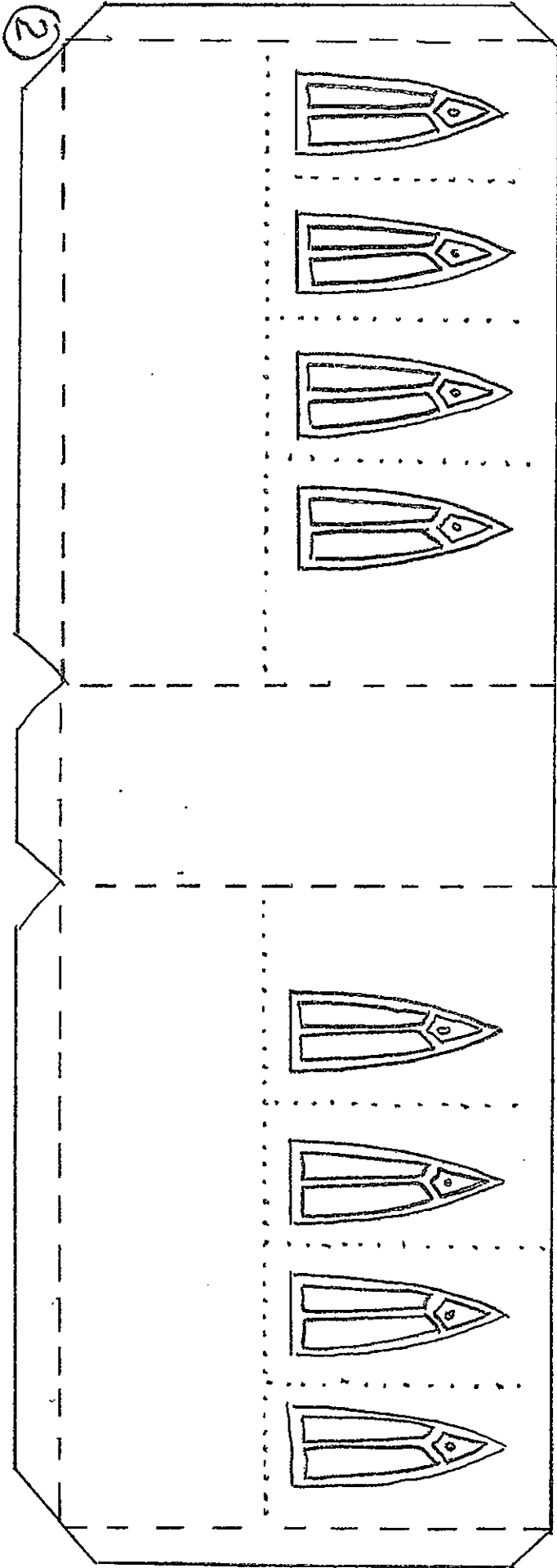

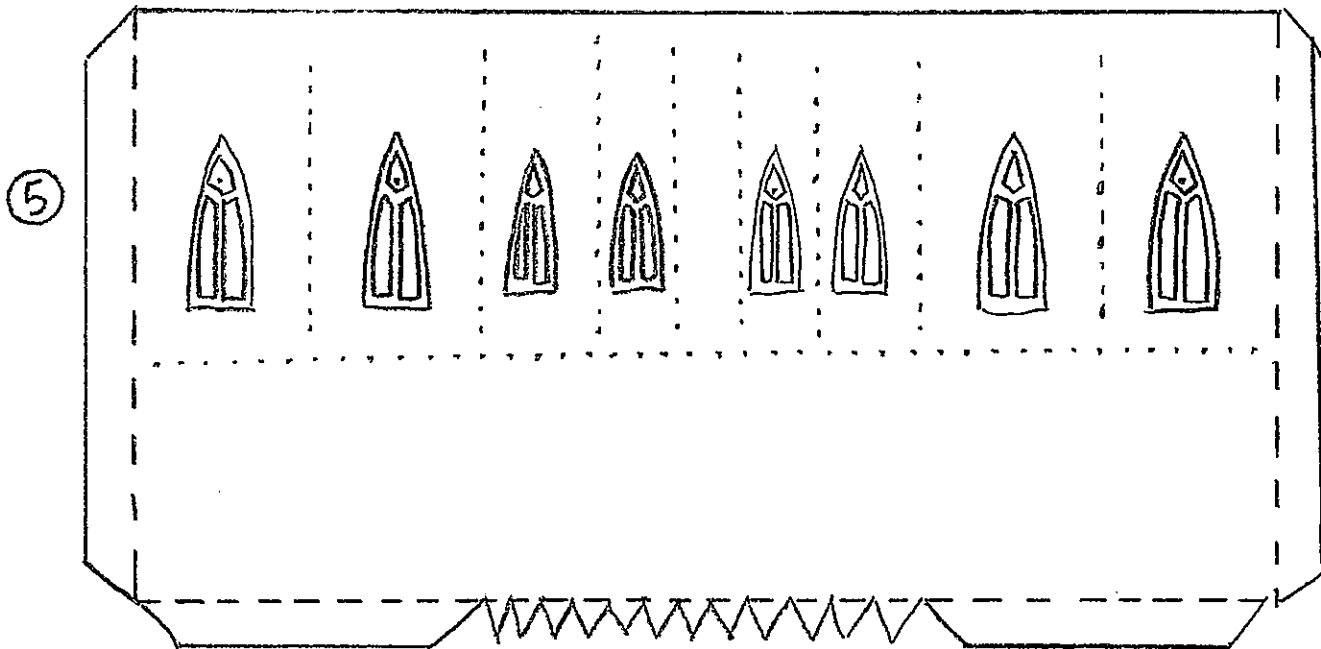
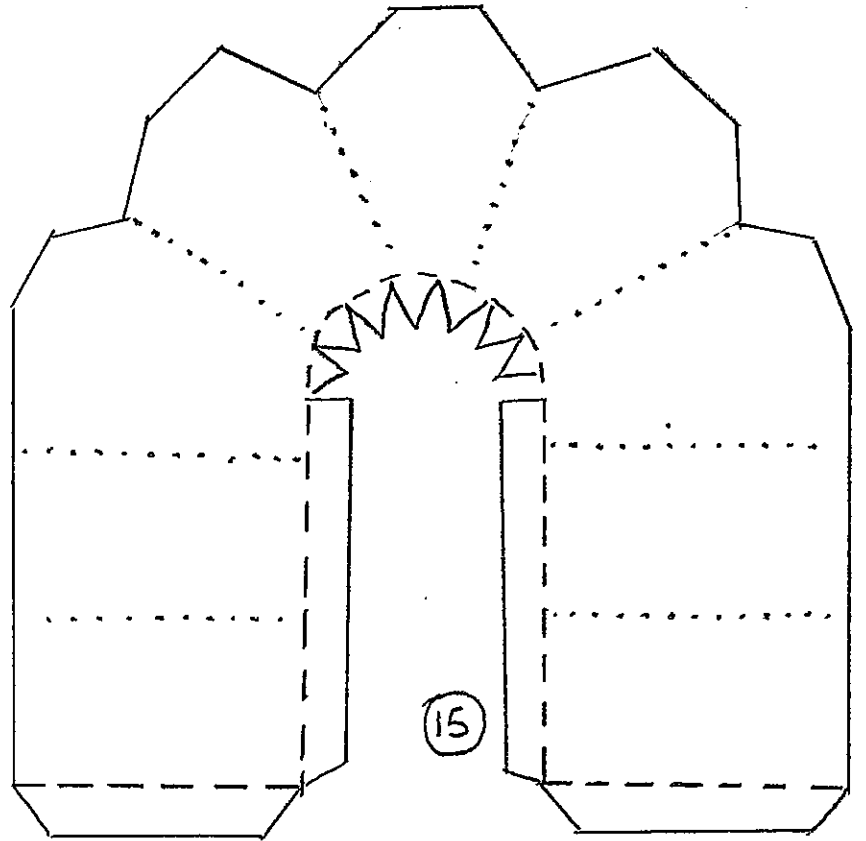
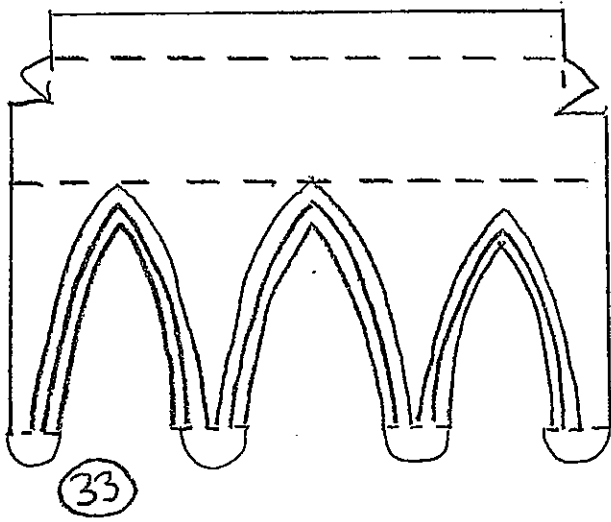

If you make this Cathedral...

SEND ME A picture!

I will email you a certificate of contribution!

[willkalif@comcast.net](mailto:willkalif@comcast.net)

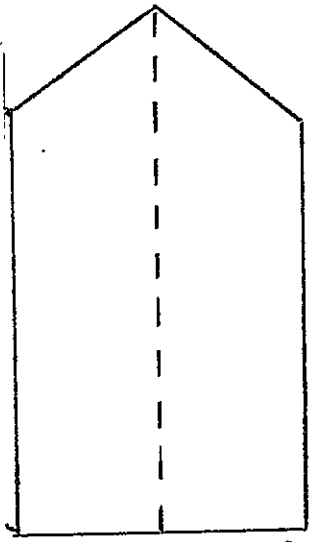

8



44

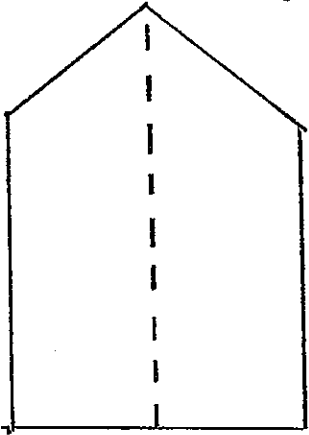

9



43

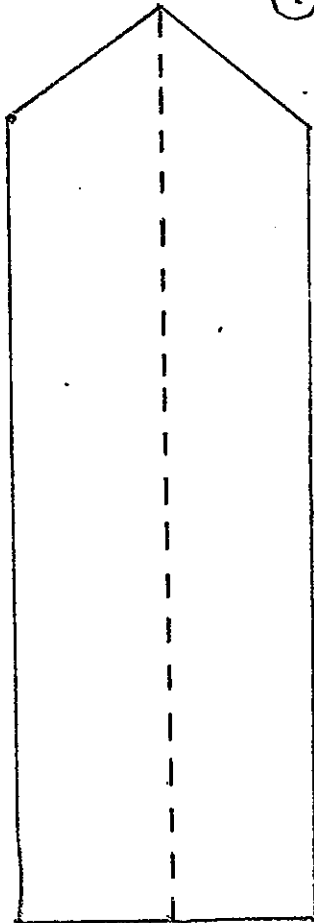

7

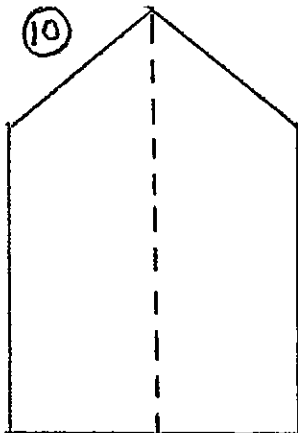

10

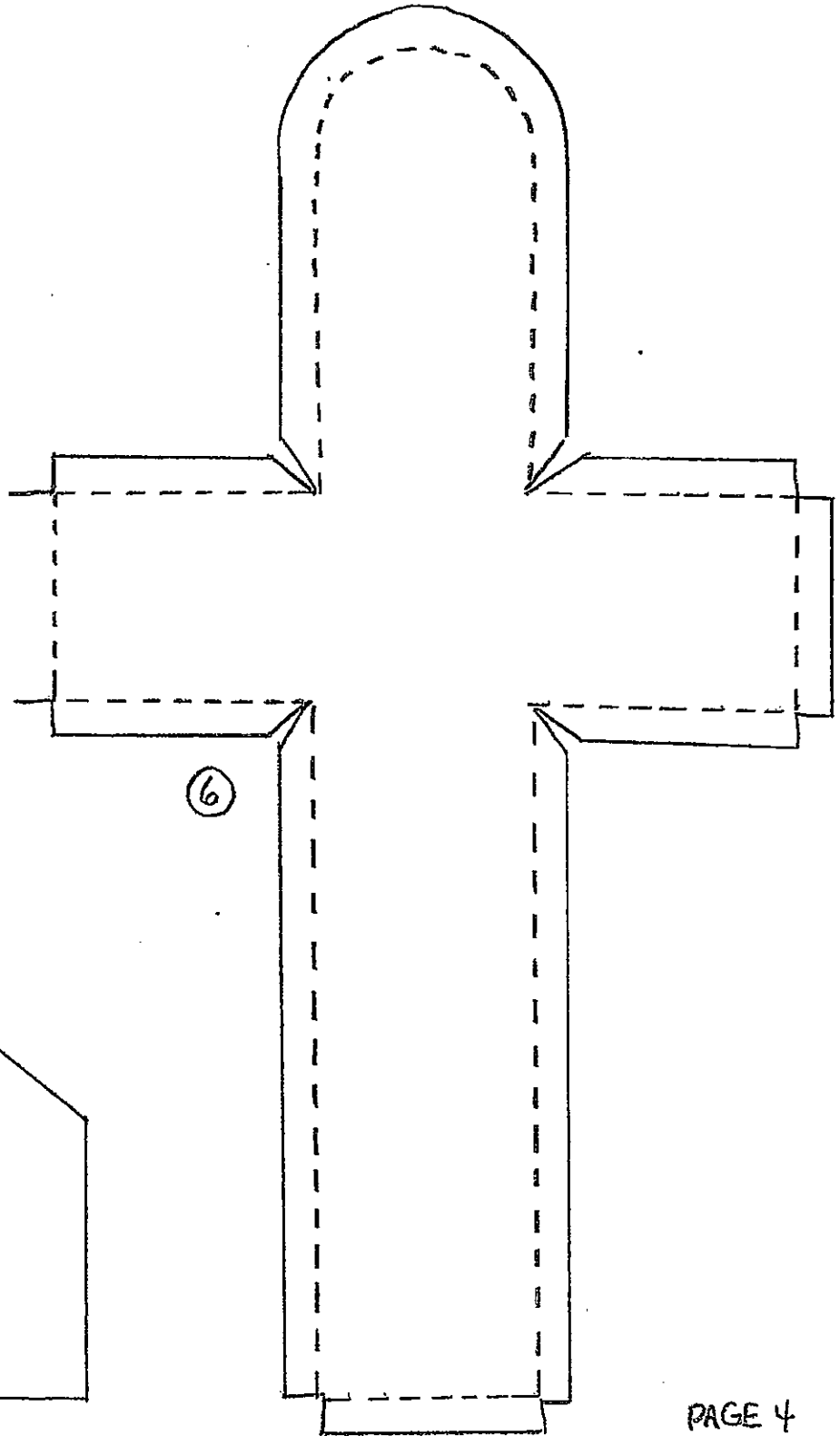

6

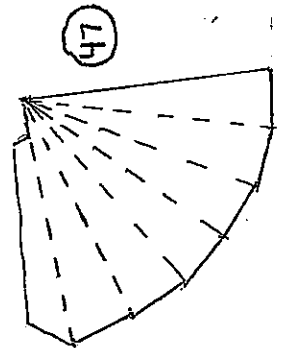
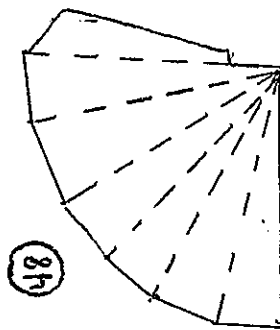
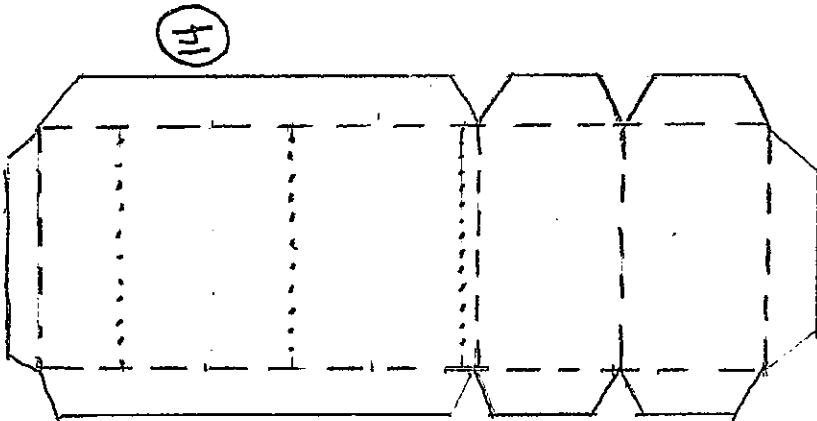
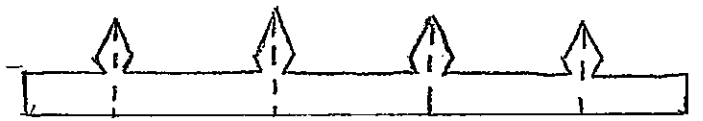
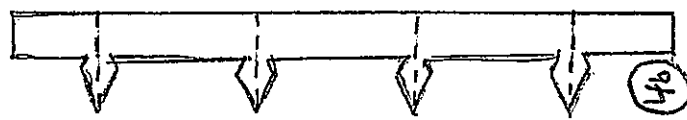
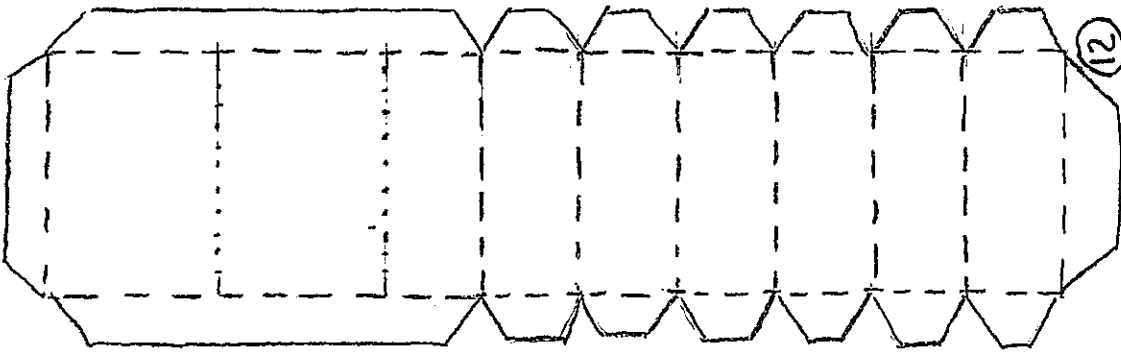
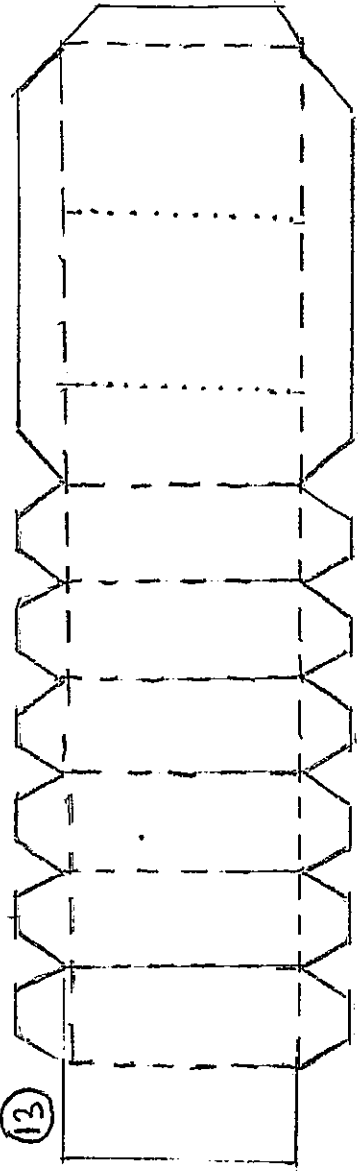
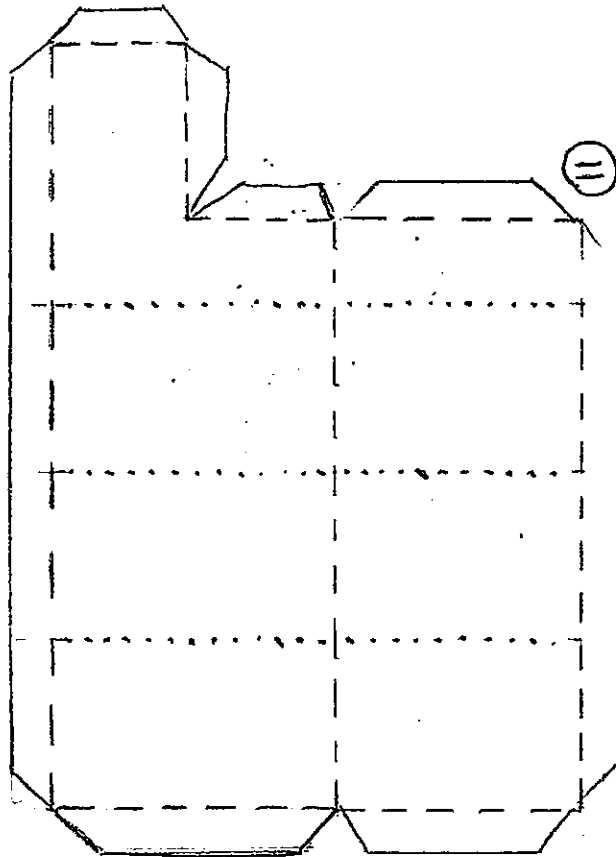
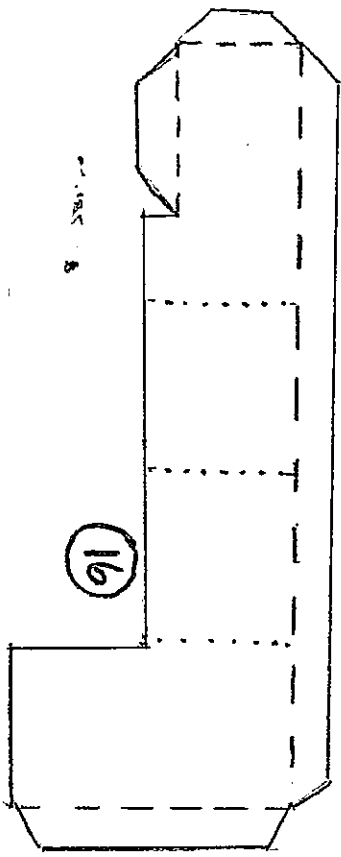

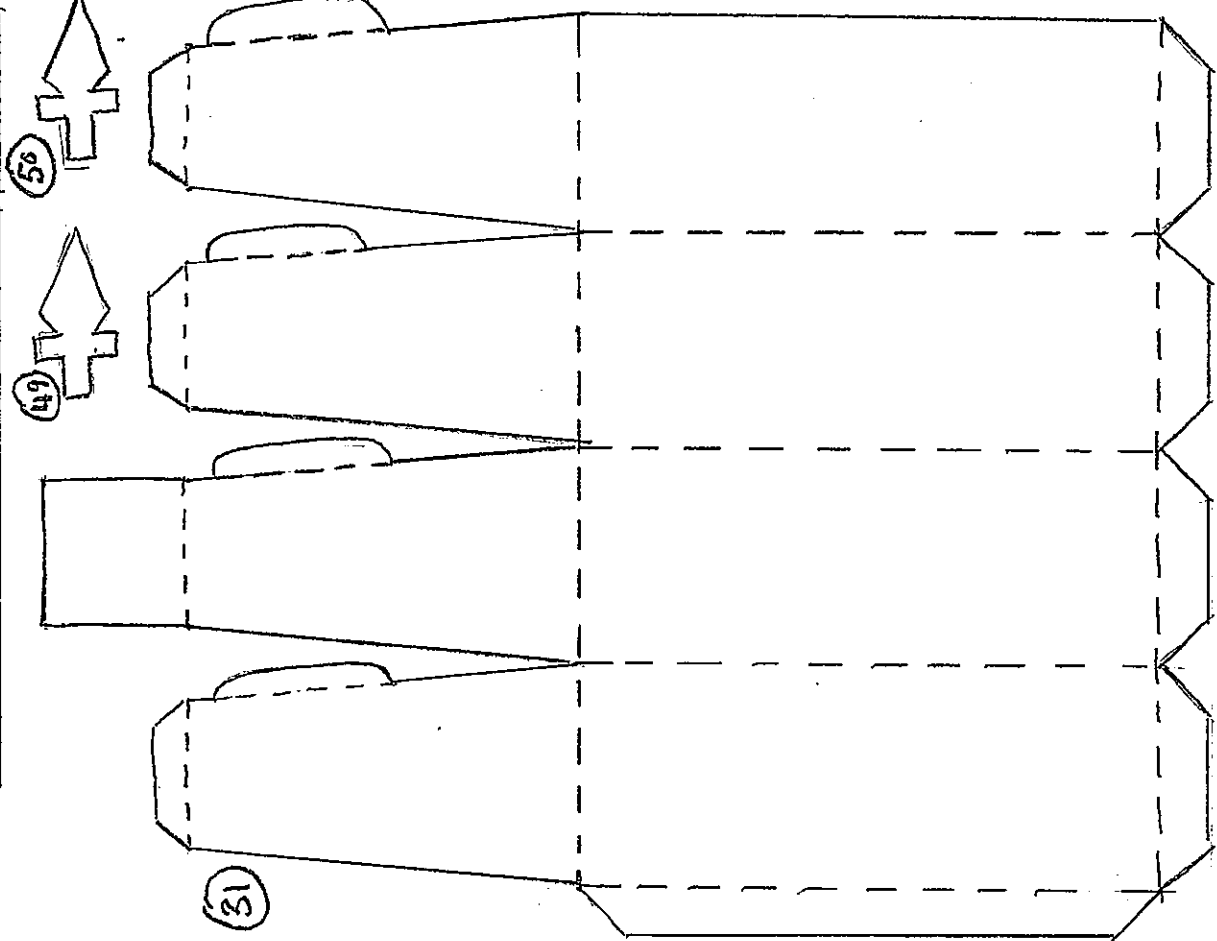
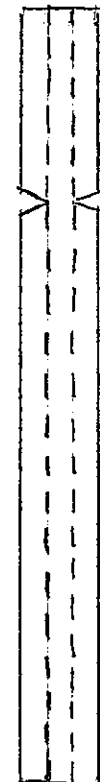
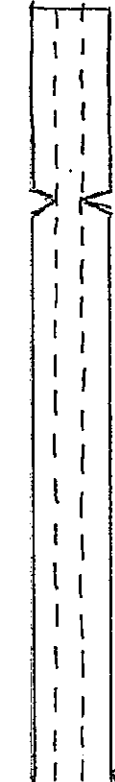
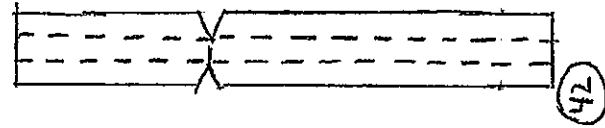
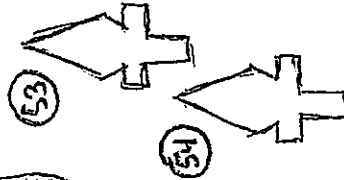
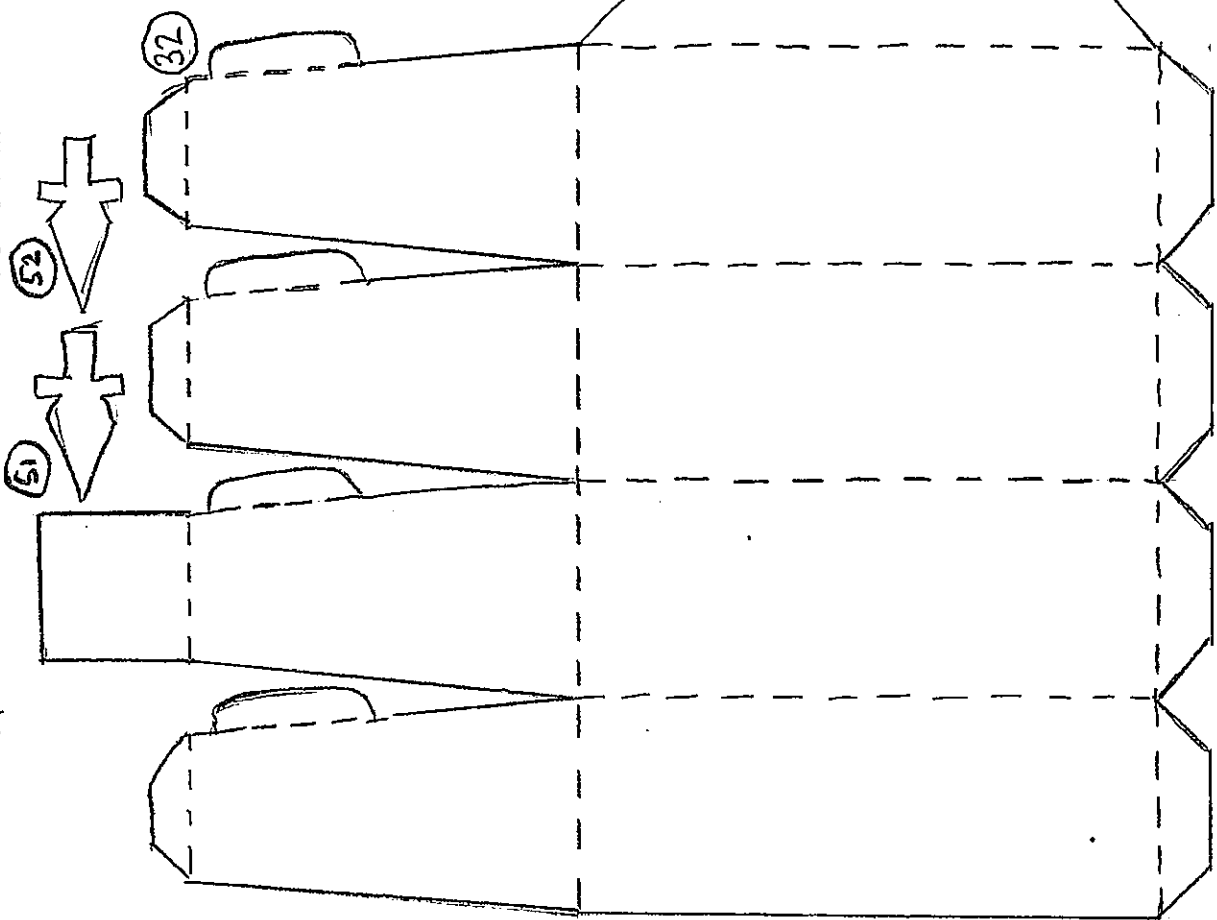
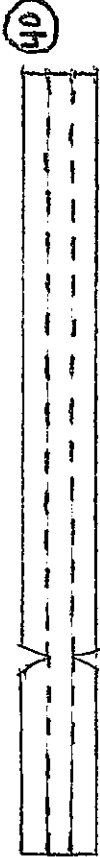
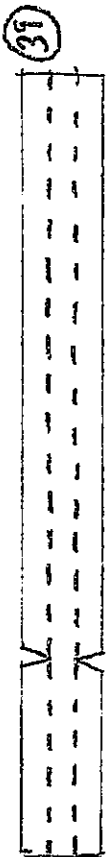

58

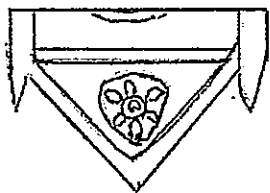

59

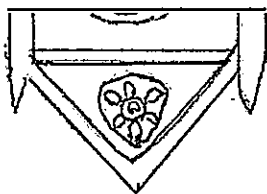

57

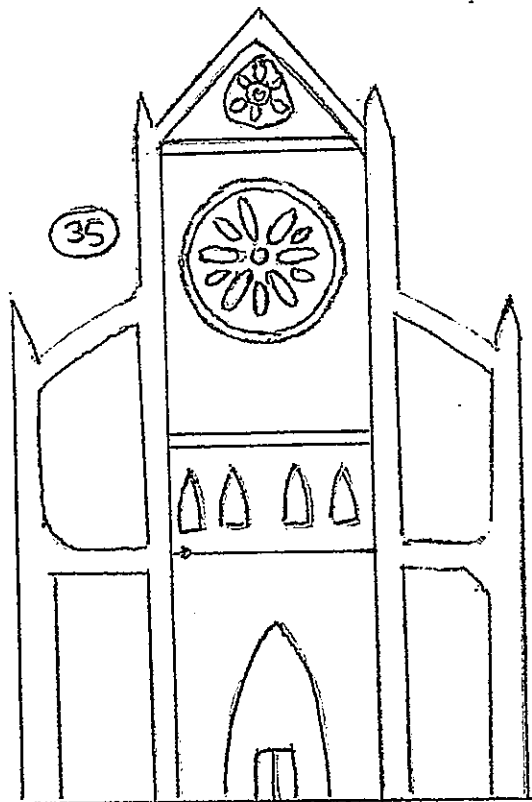
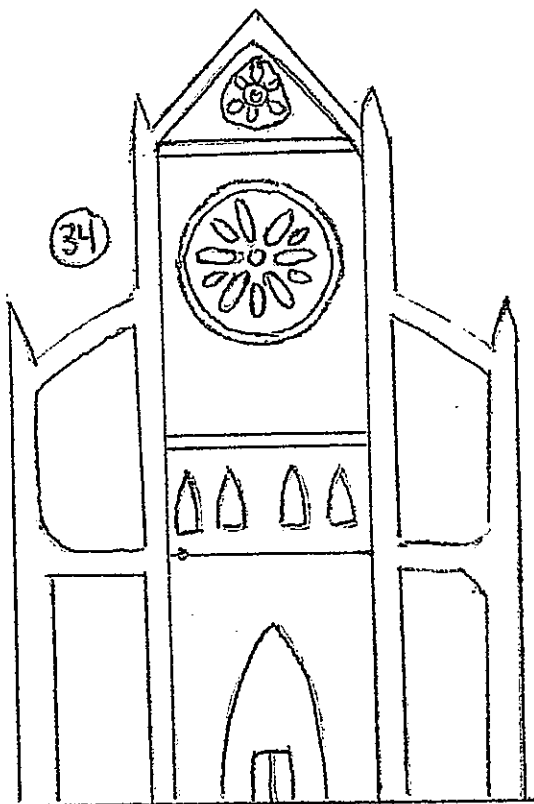
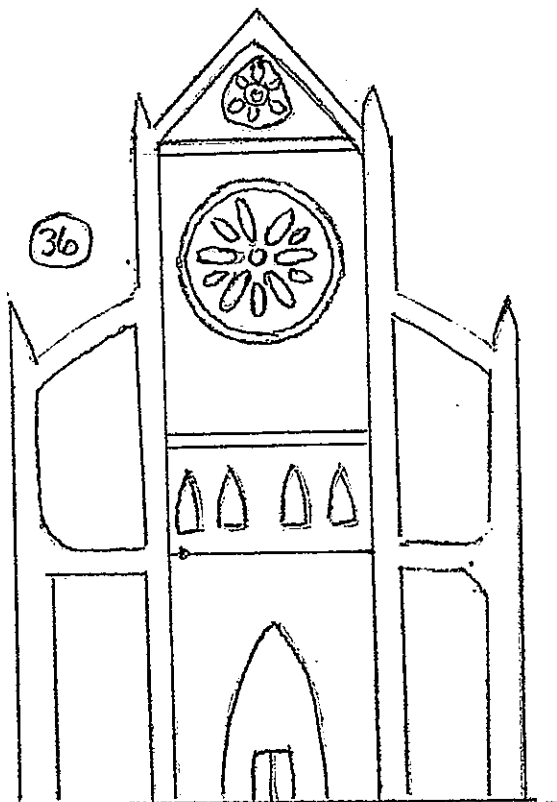
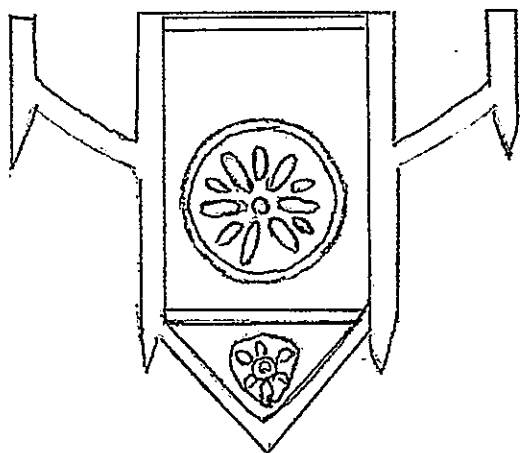

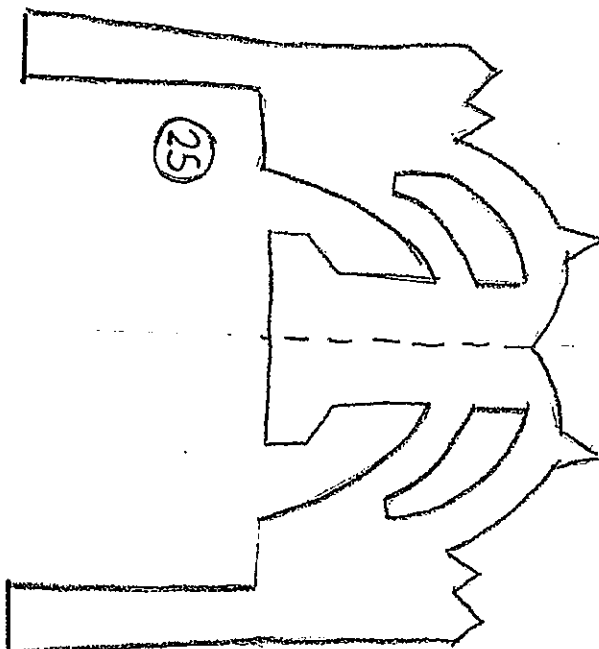
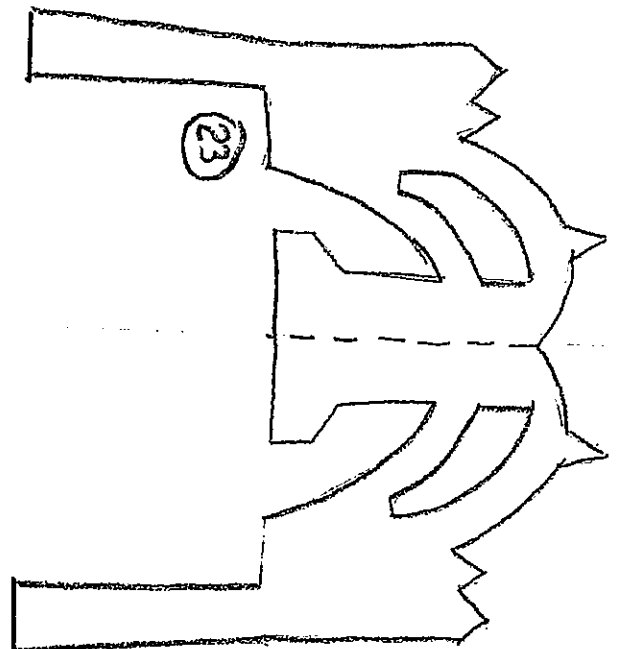
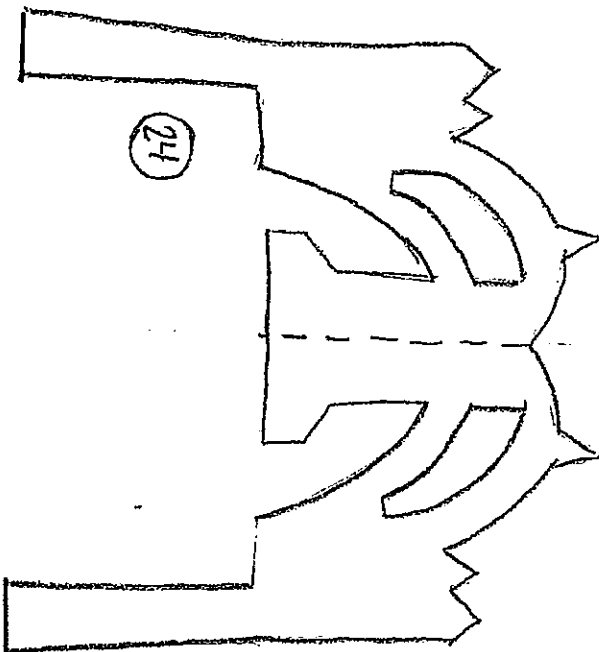
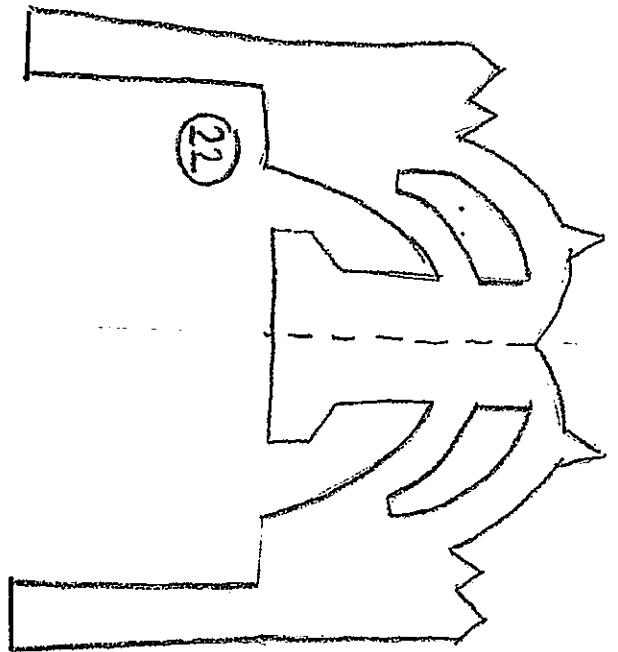
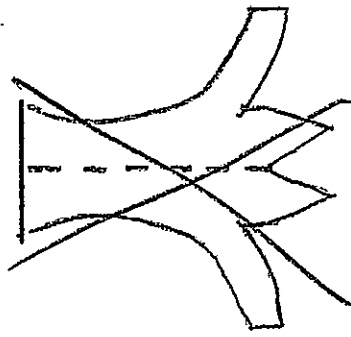
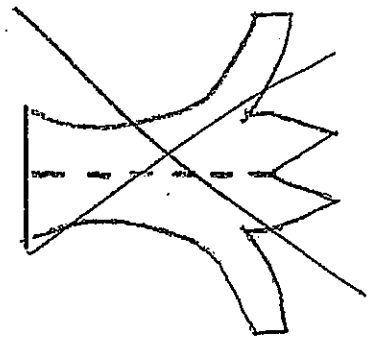

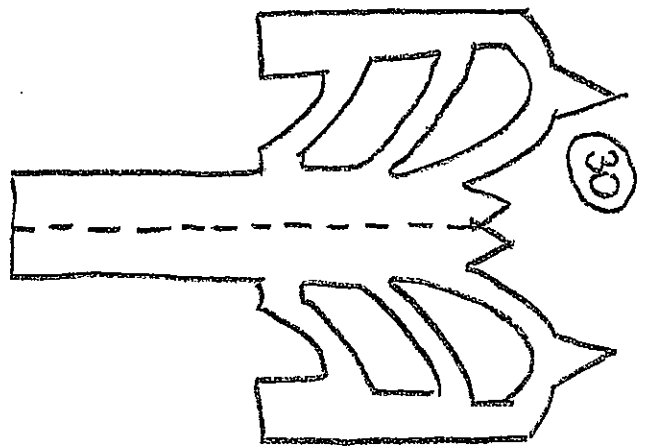
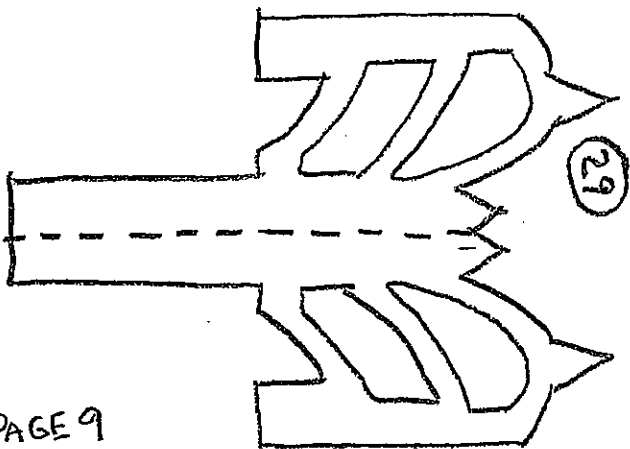
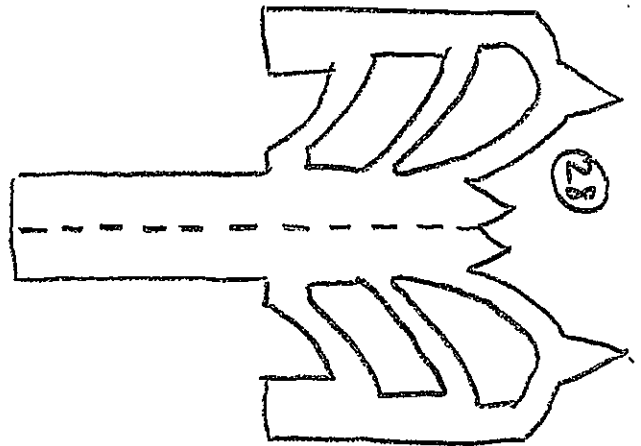
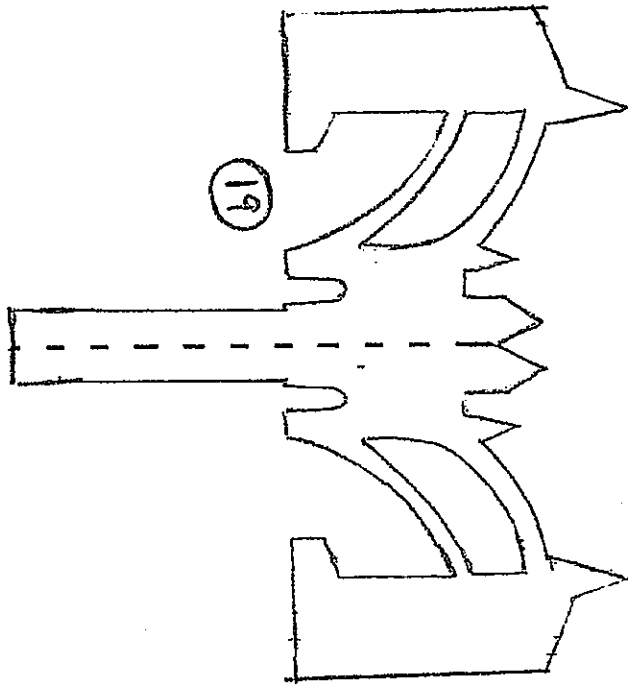
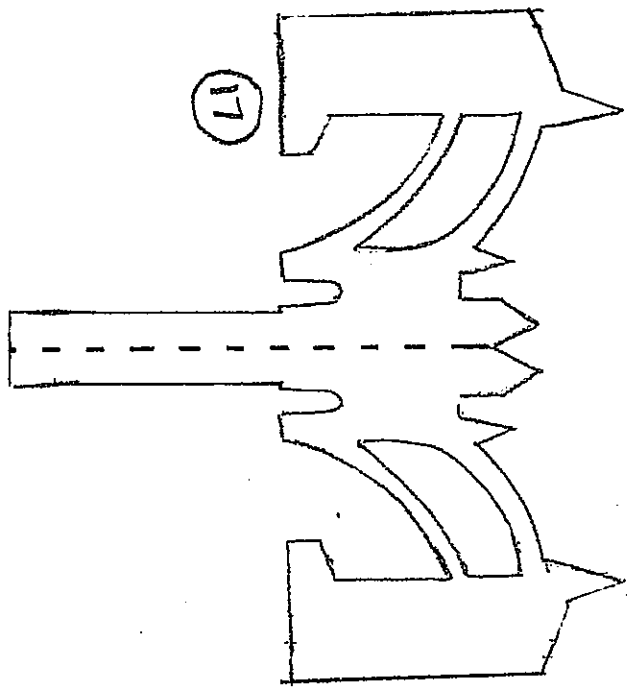
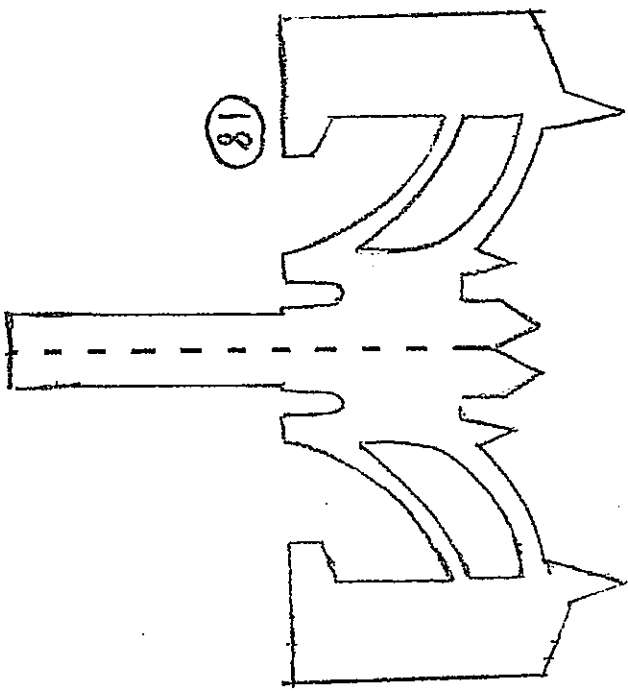



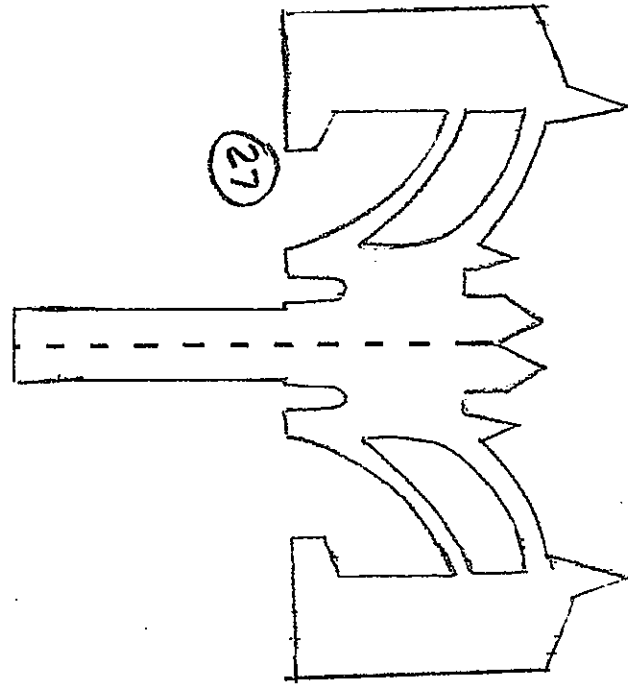
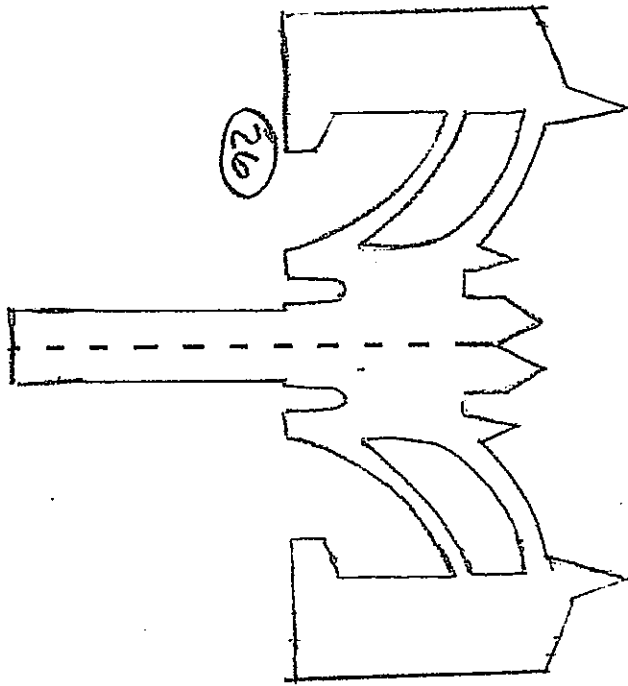
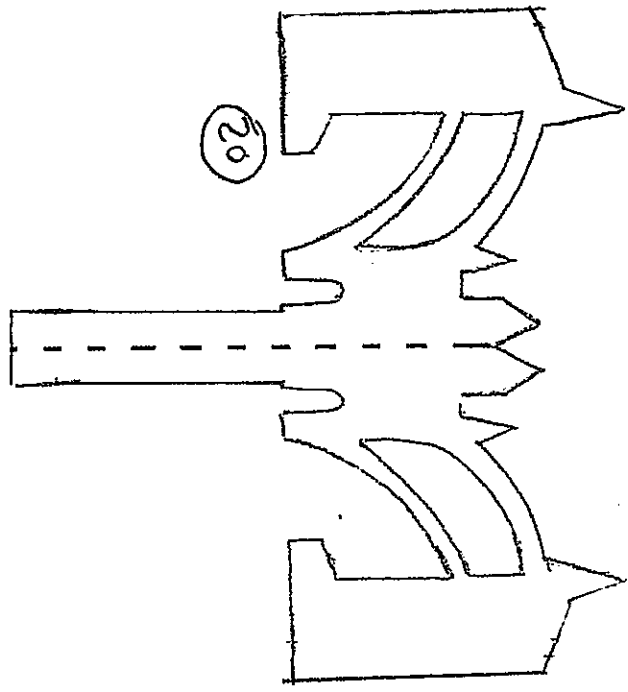
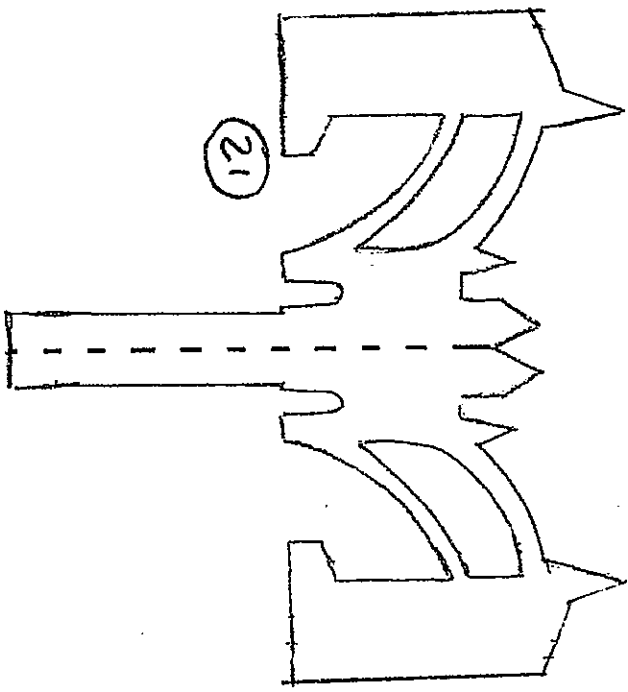

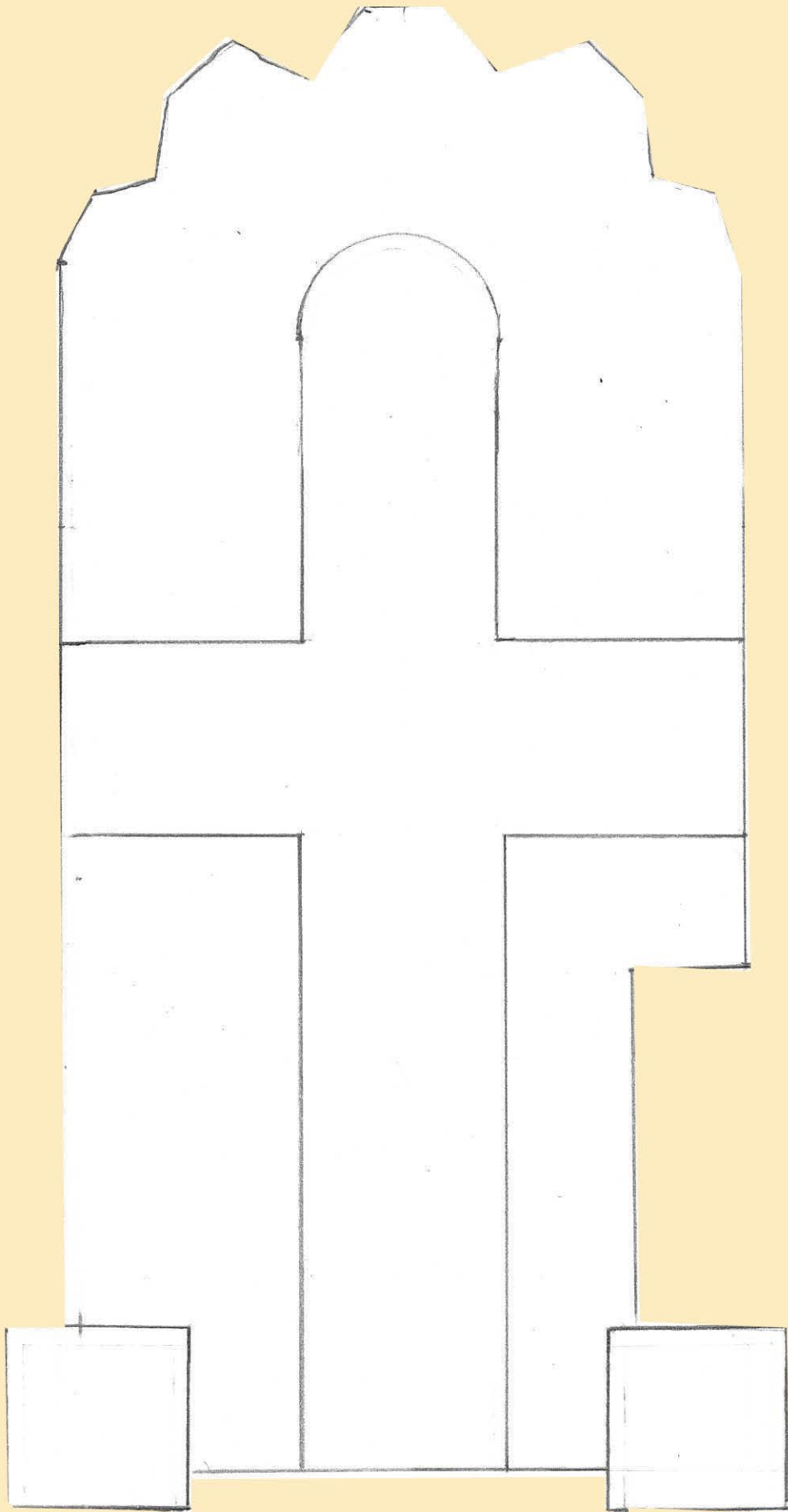

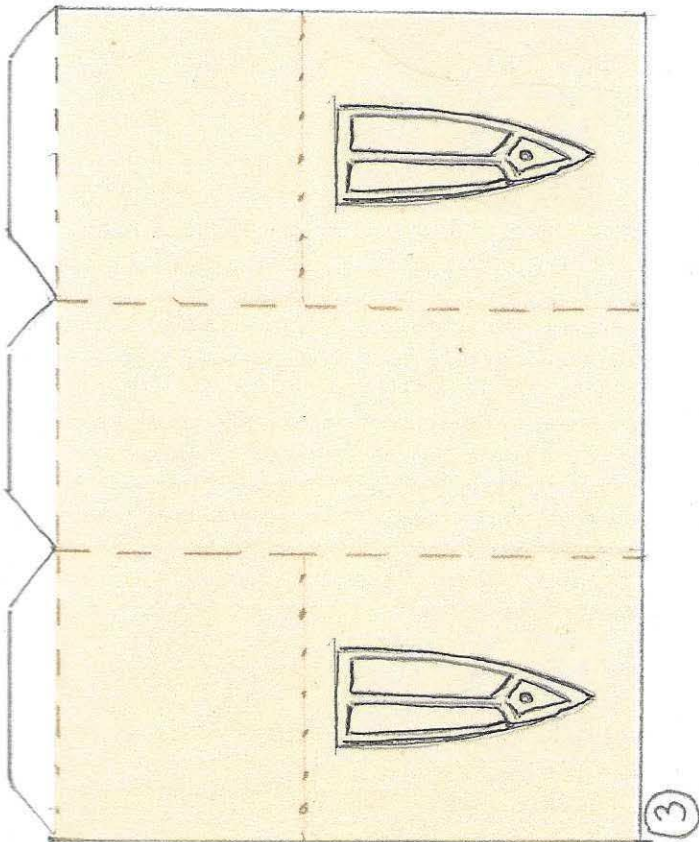
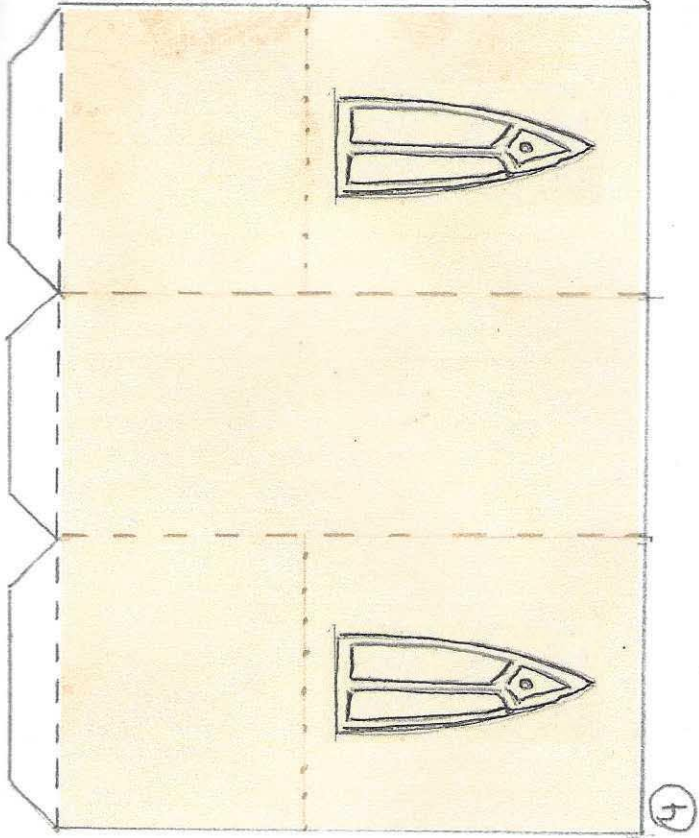
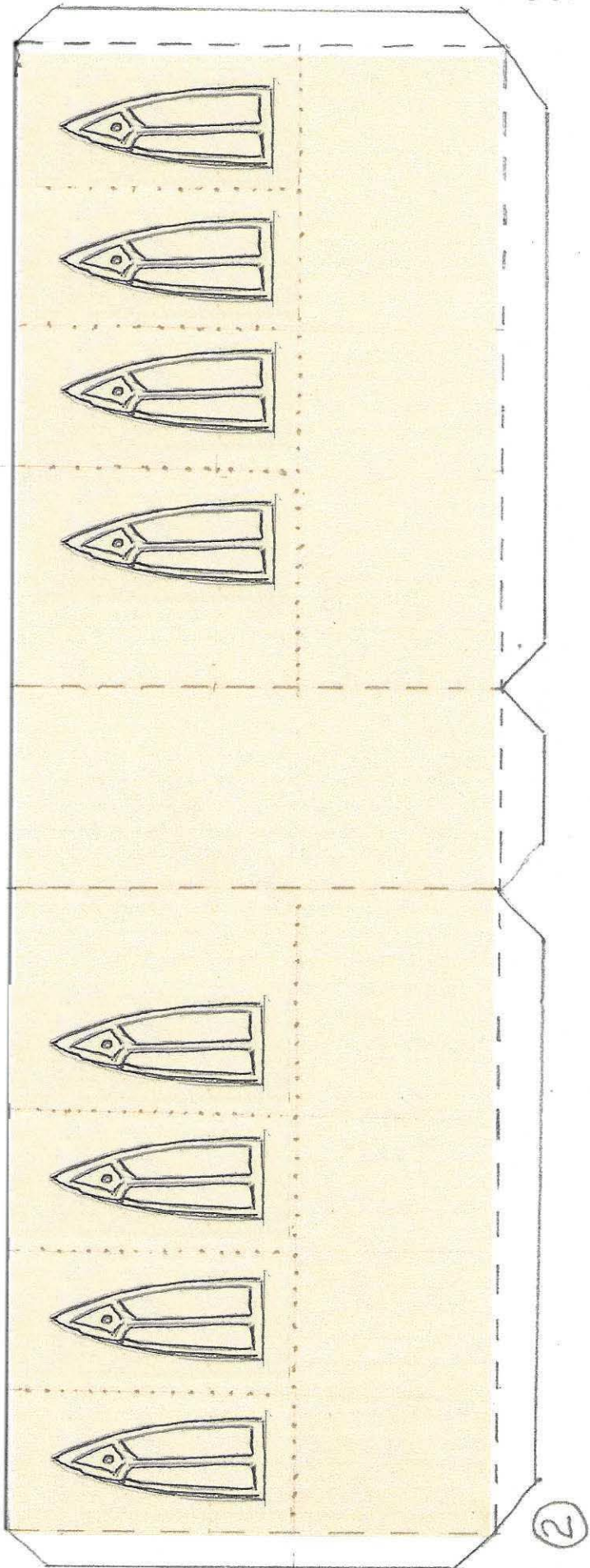

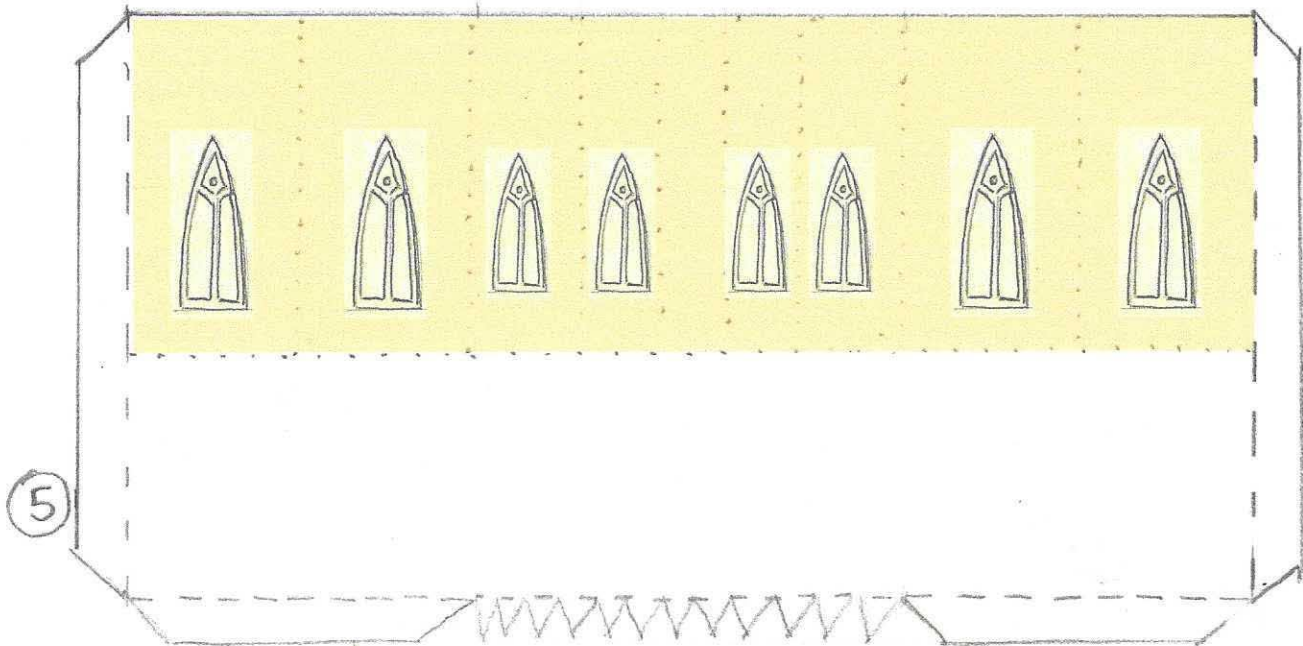
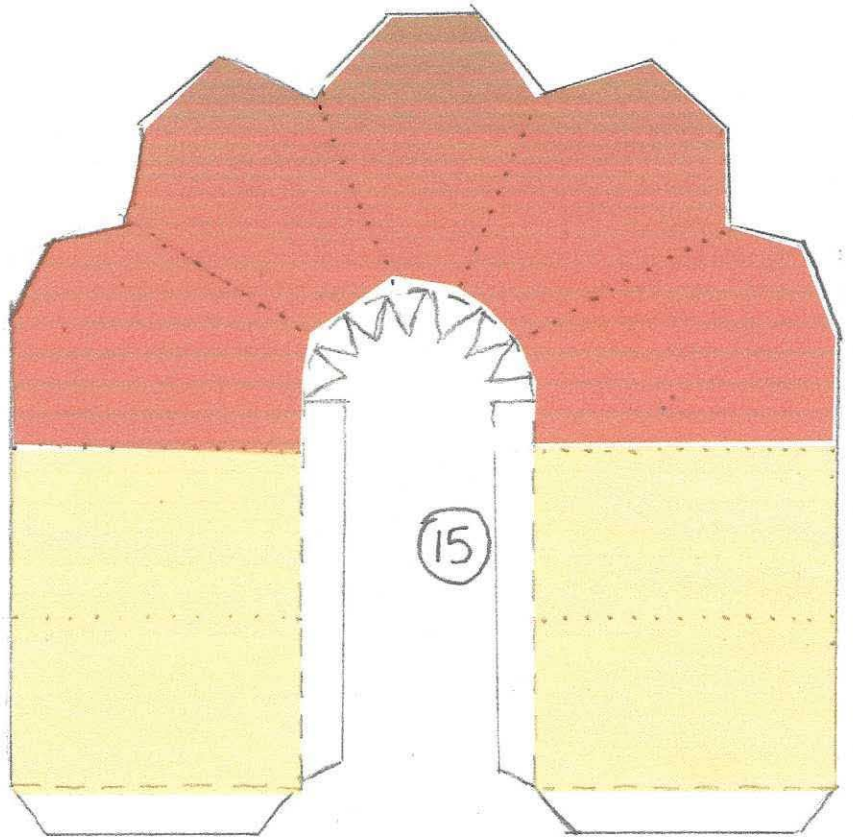
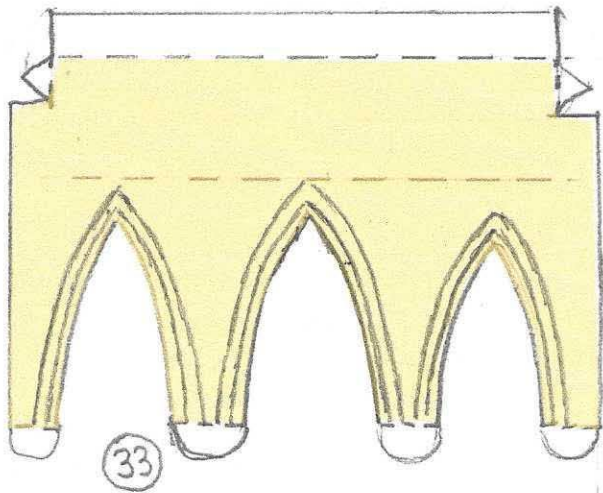

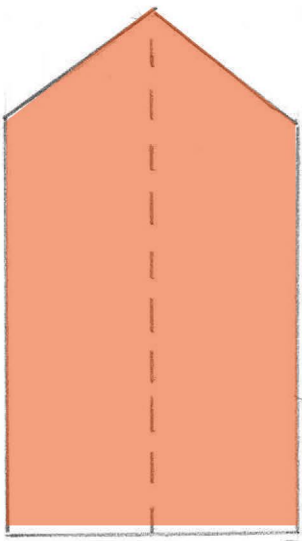

8



44

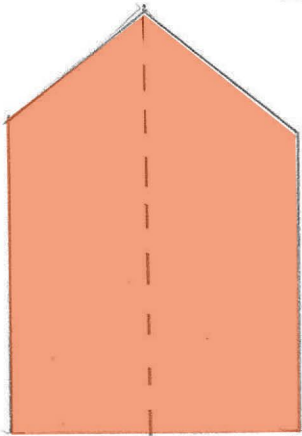

9



43

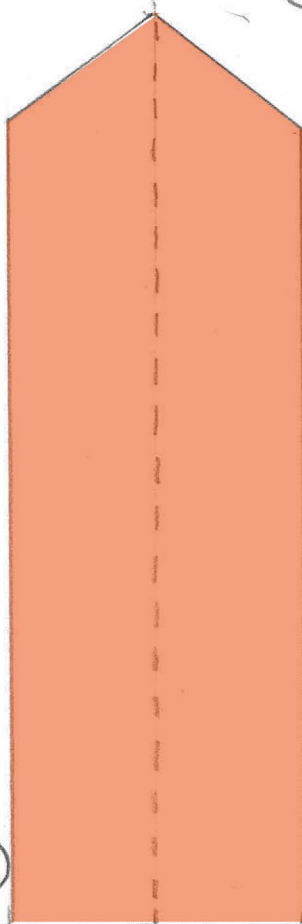

7

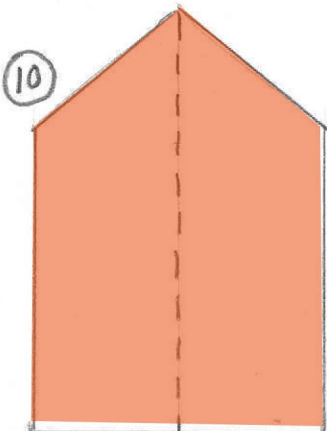

10

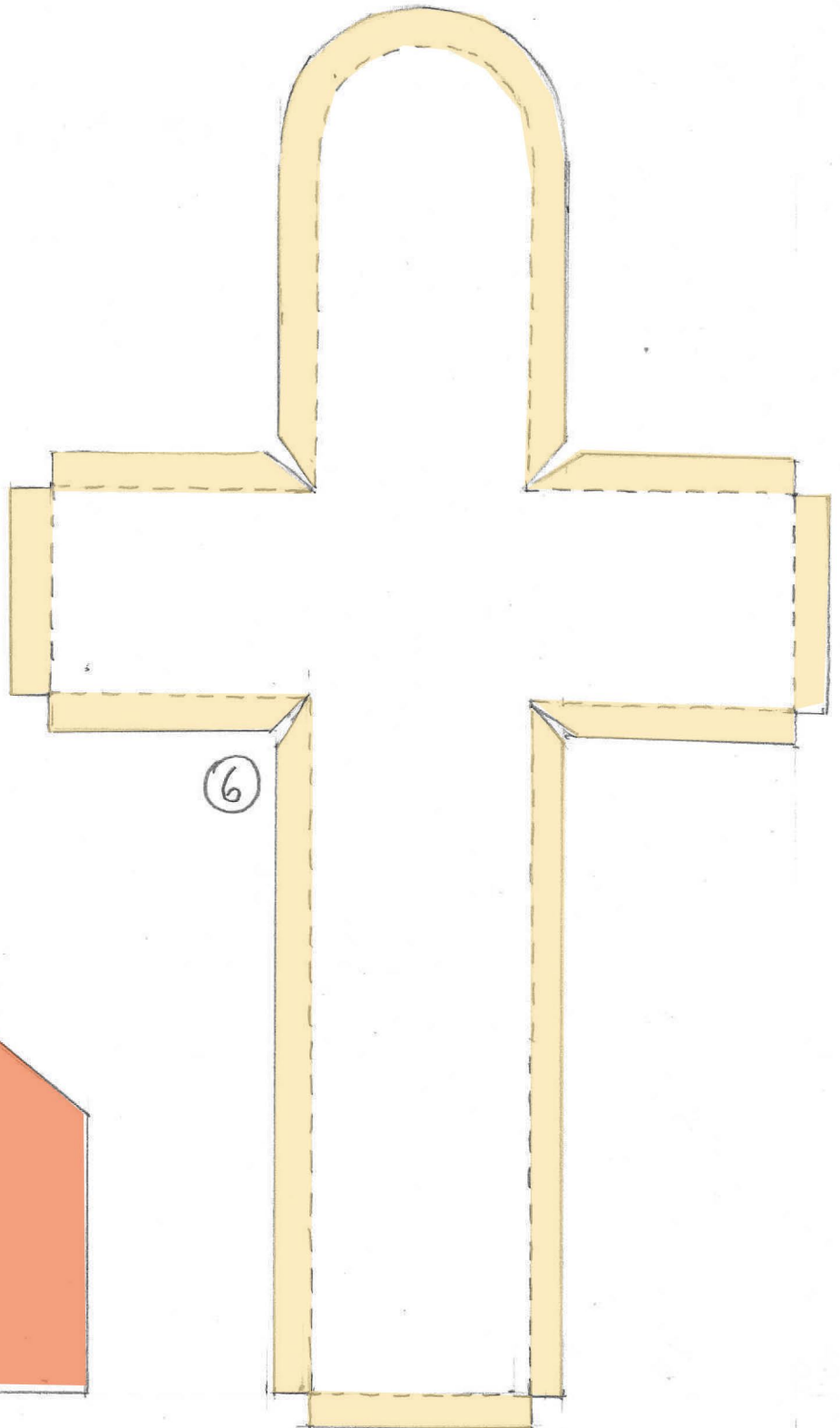

6

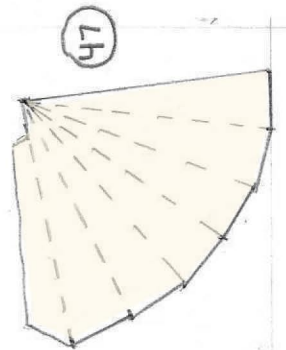
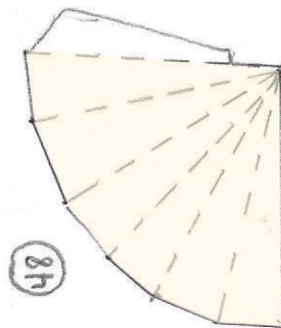
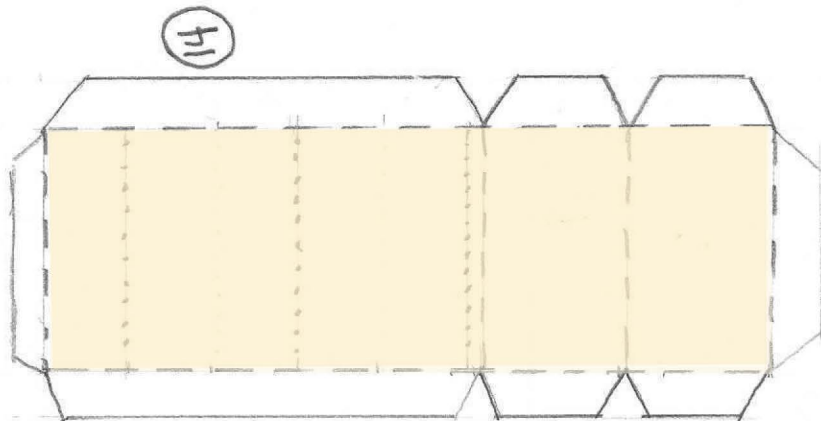
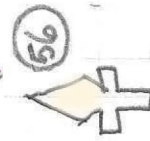
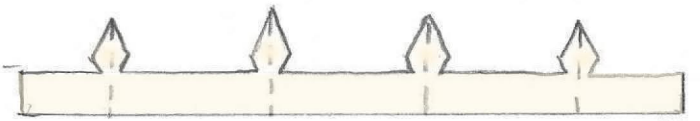
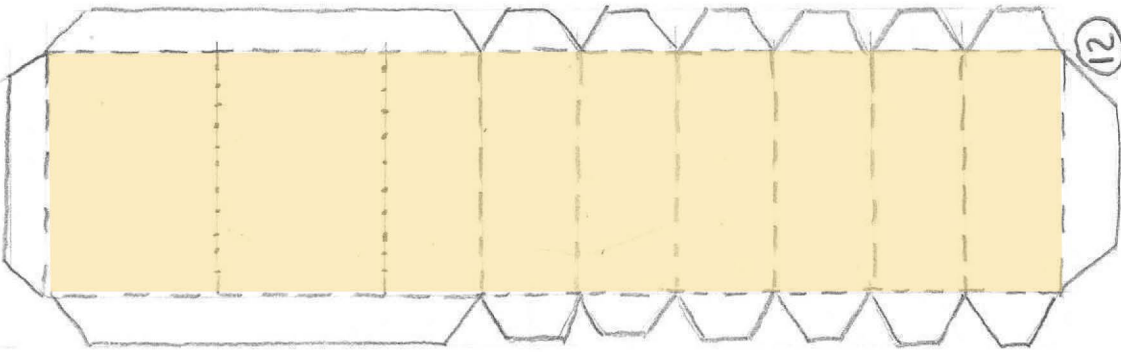
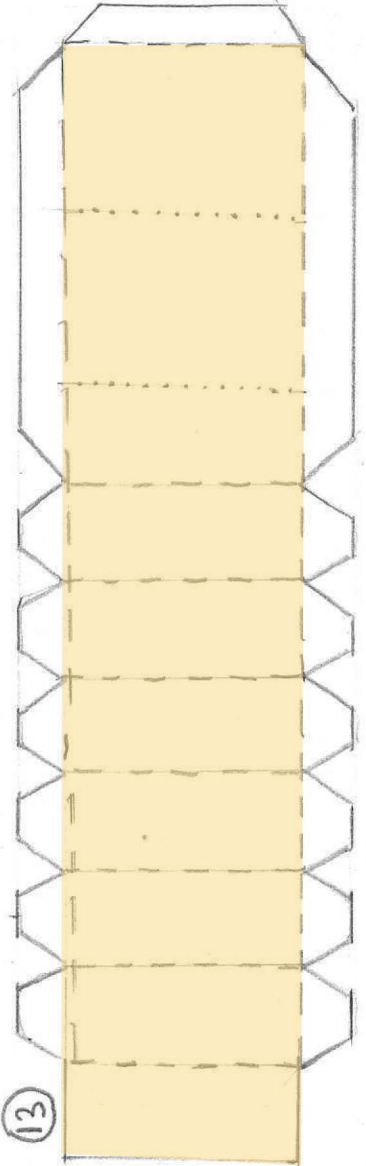
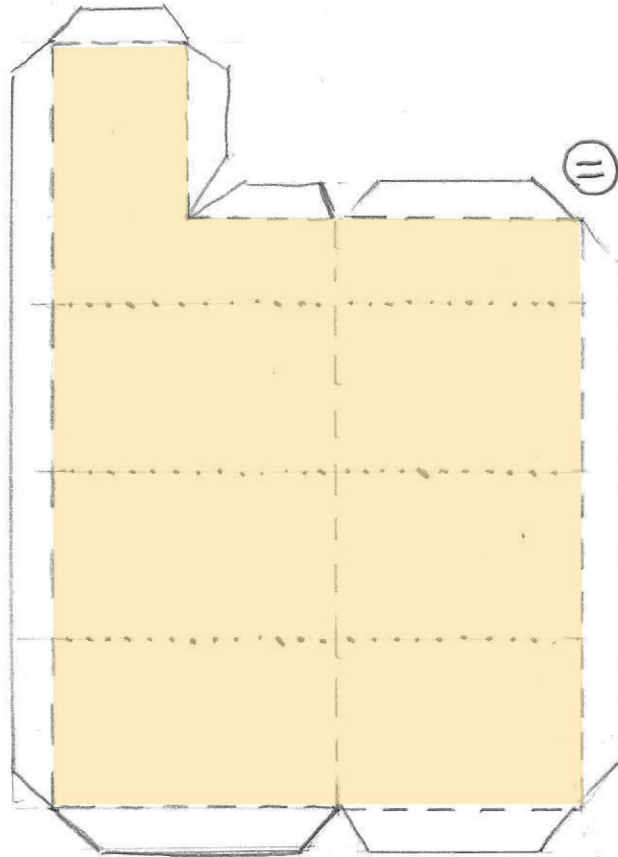
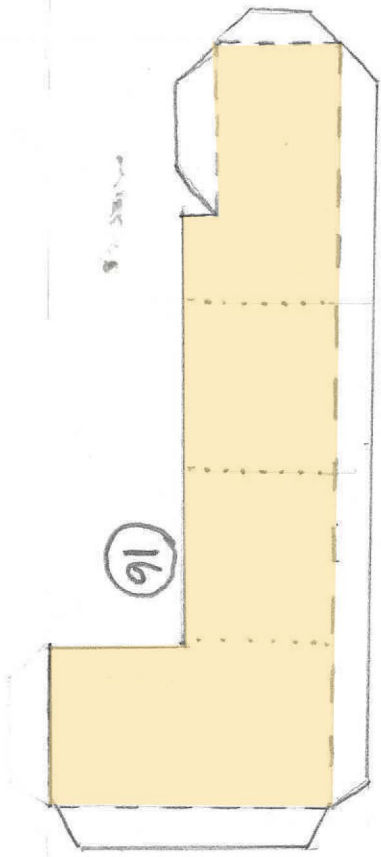

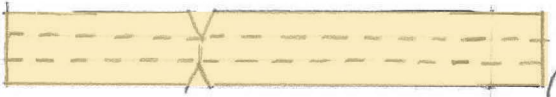
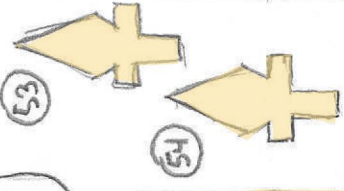
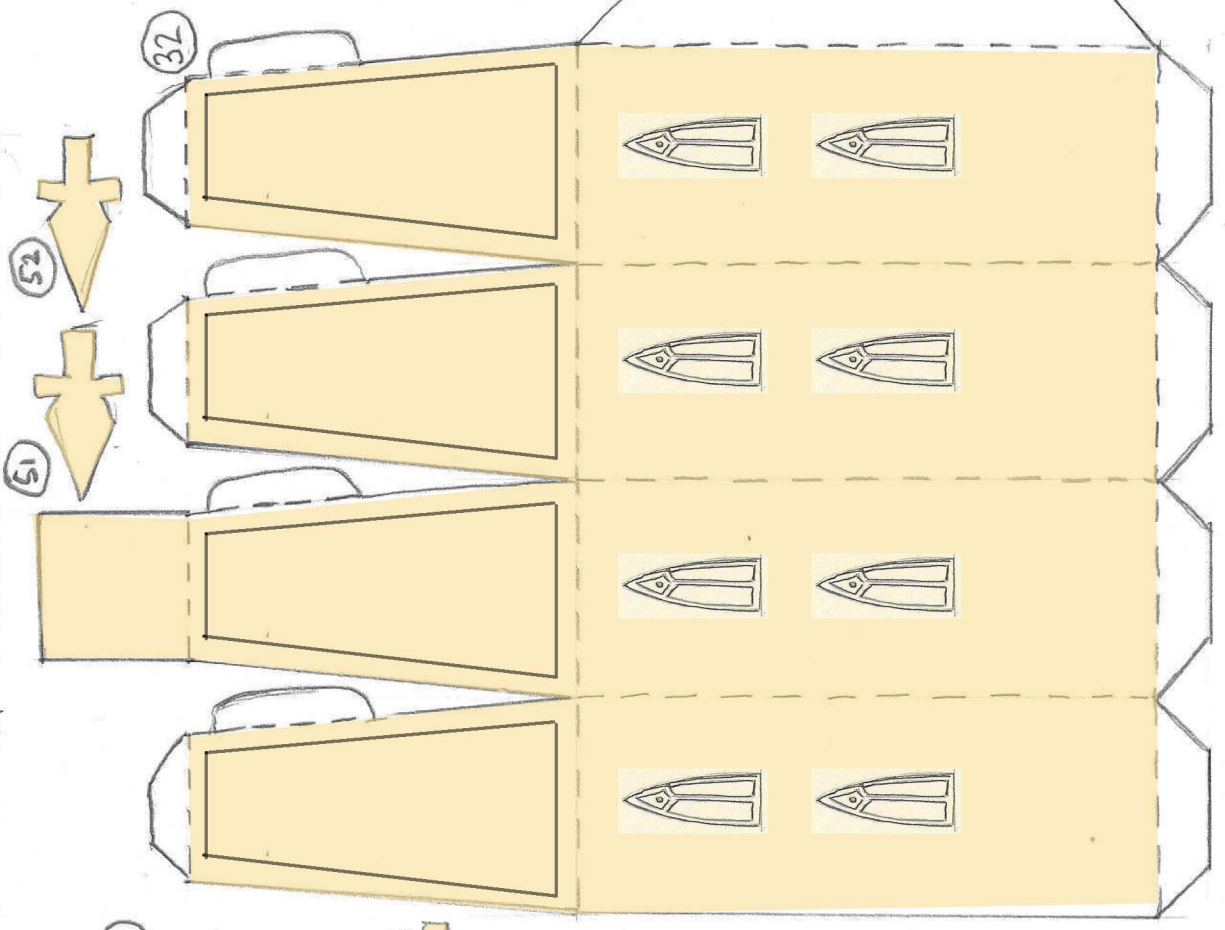
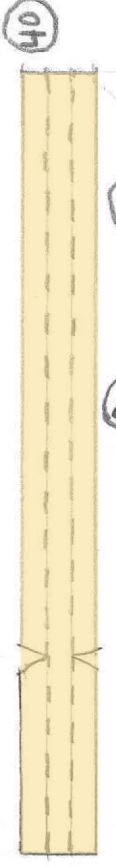

42

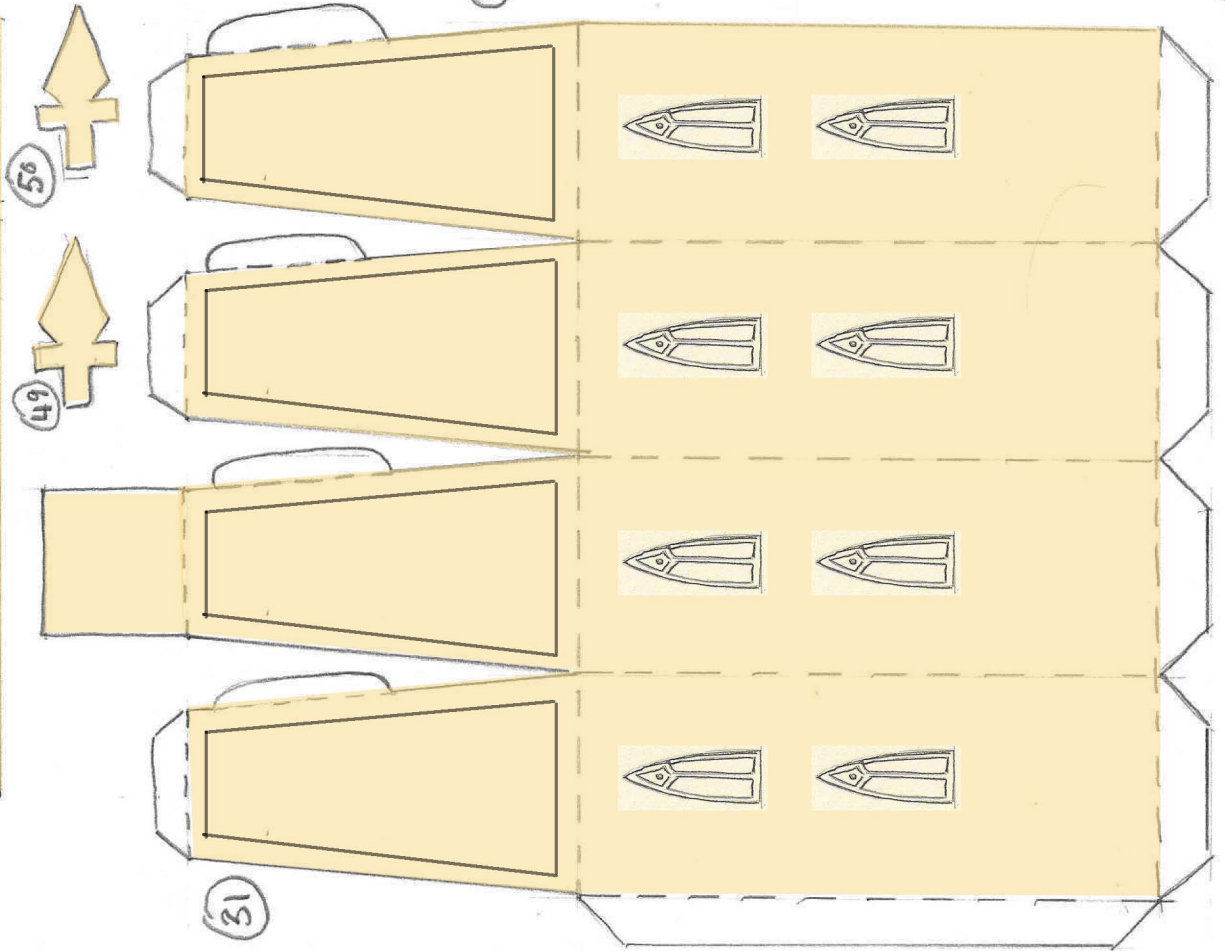
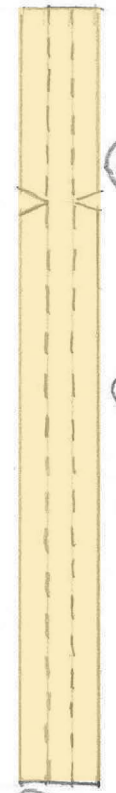

37

38

31

58

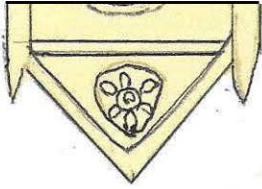

59

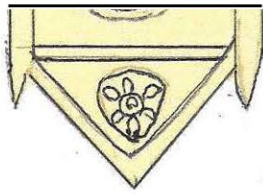

57

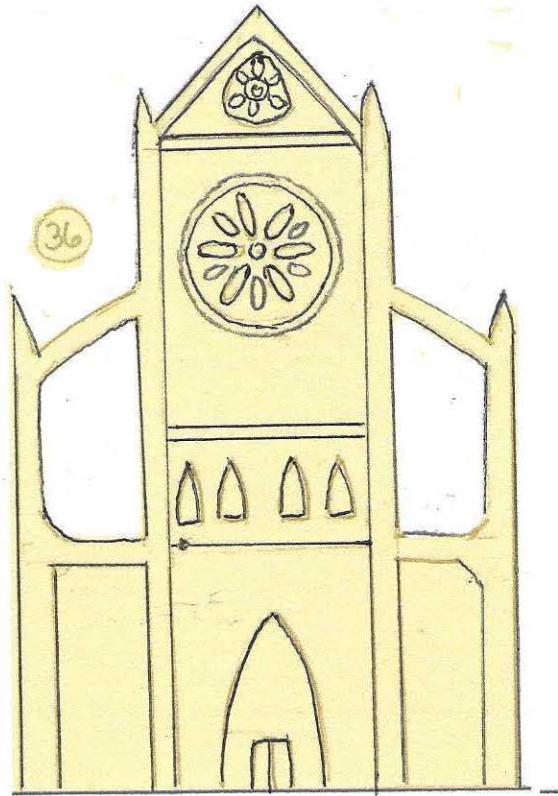
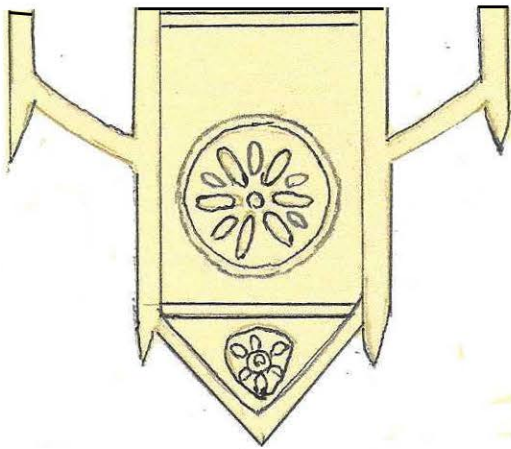

34

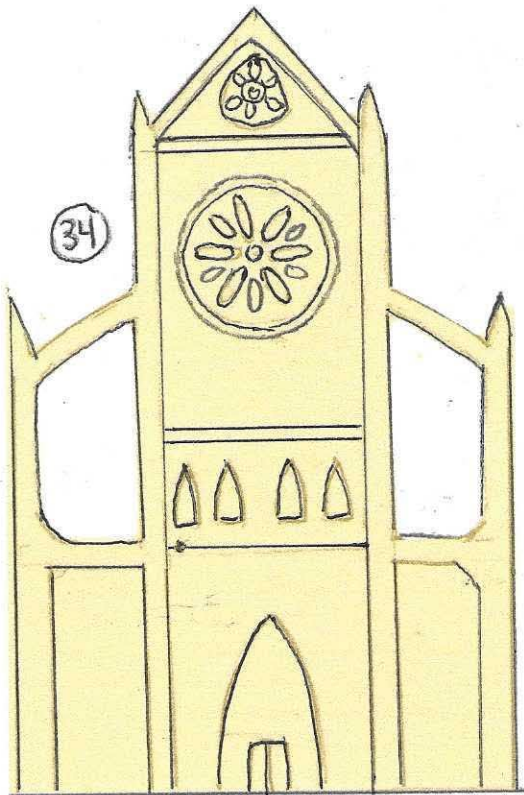

35

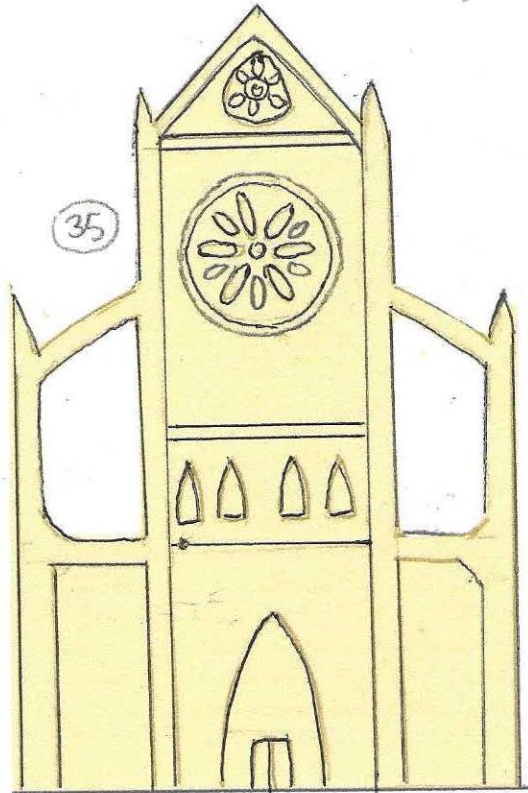



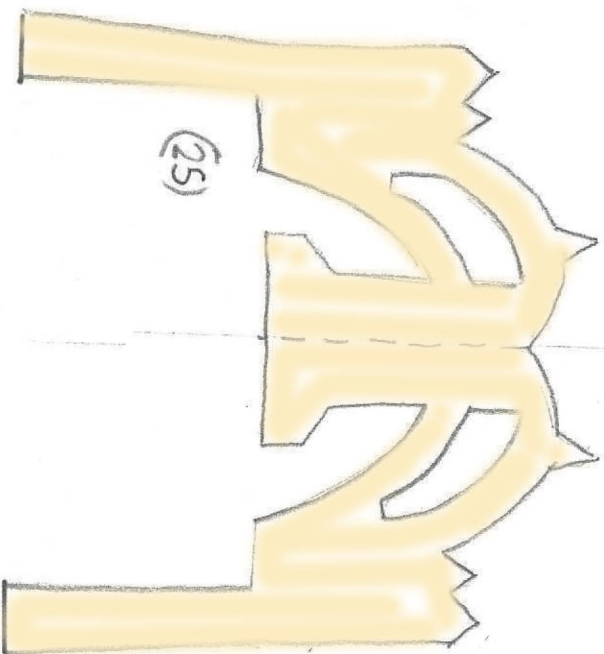
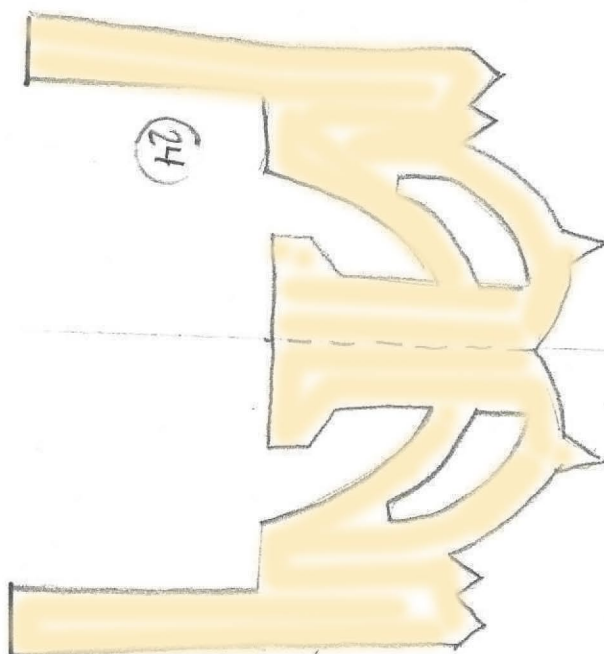
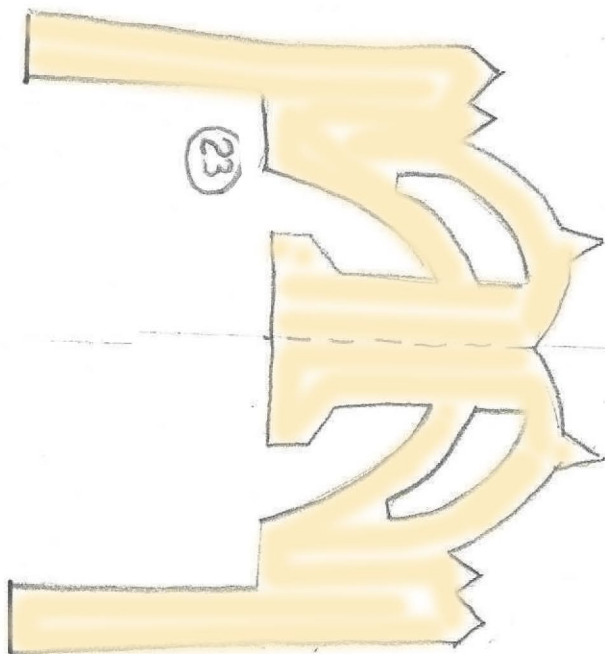
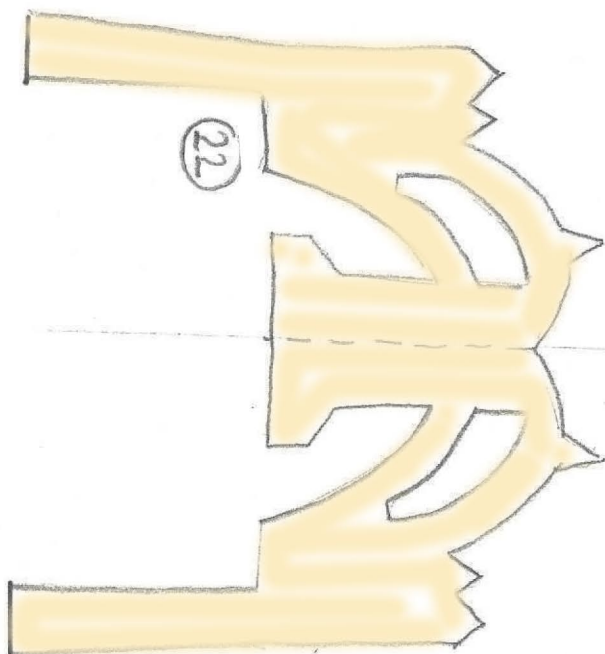

17

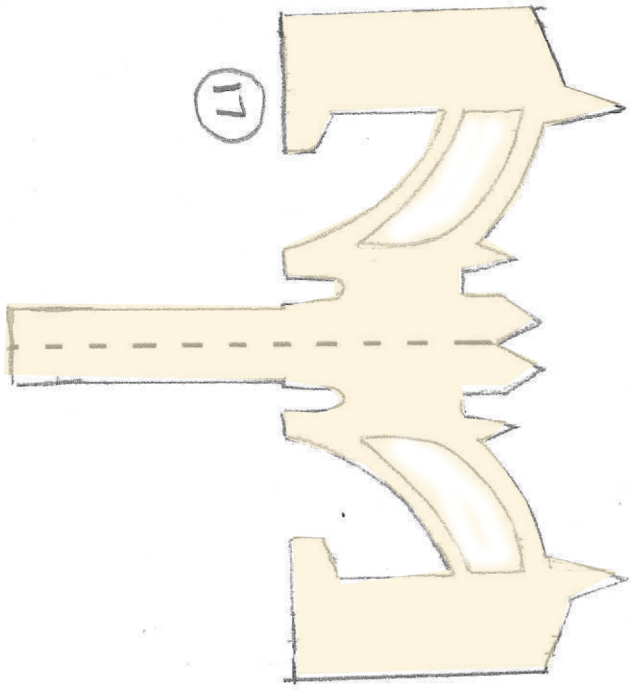

18

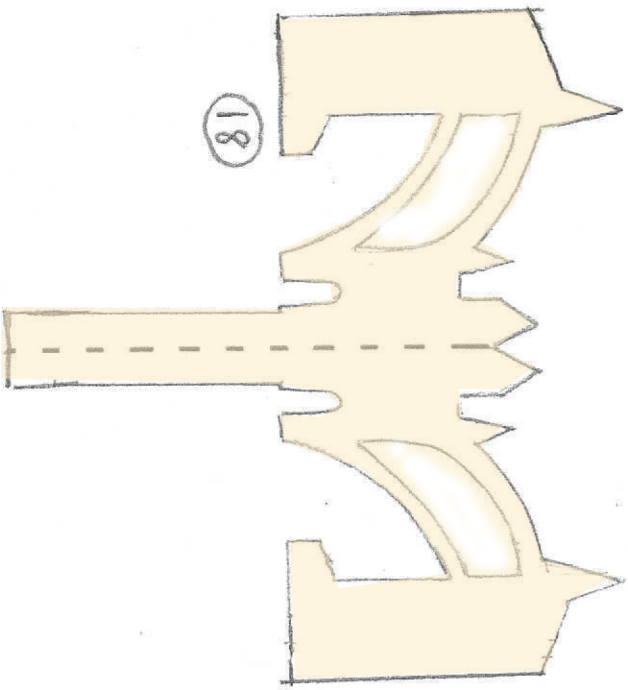

25

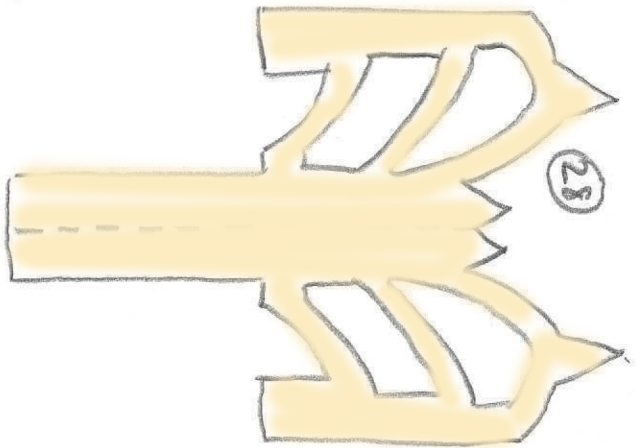

19

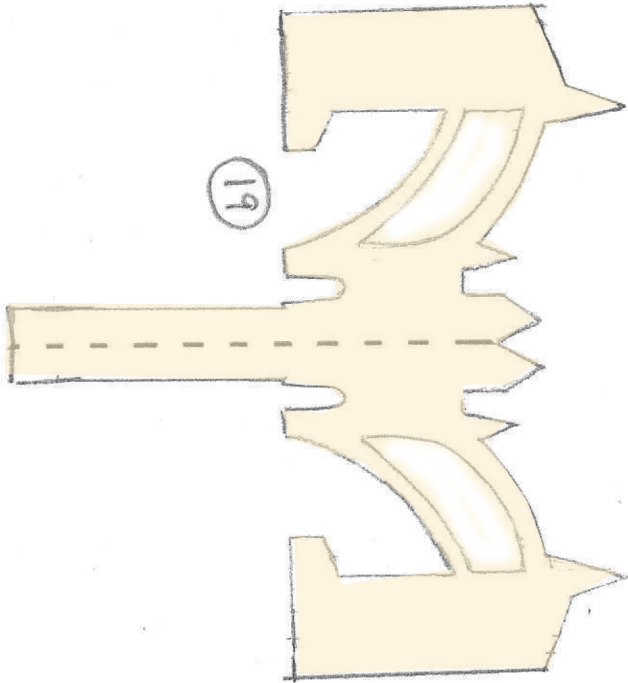

30

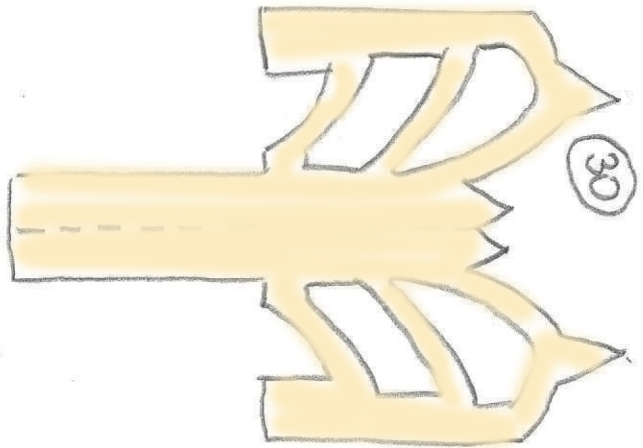

29

